

Alpha9155sc

Royal Consumer Business Products

Cash Register Manual

99 Departments

1600 PLUs

Easy Set-up

Instructions

Page 15

WELCOME...

to the Royal family of fine business machines.
We sincerely hope you will enjoy the many benefits
of being associated with a distinguished product
name that has represented both quality and
customer satisfaction since 1905.

This electronic cash register is designed to help your business function smoothly by providing efficient register operations and accurate management reports. Start-up is quick and easy, yet there are many options that can be added and revised so that you can customize your operations for optimum productivity. Here are just a few of the register's many valuable features:

- Heavy-duty thermal printer with journal and receipt printouts. Allows the printing of both letters and numbers on the receipt and journal tapes. Each department can be programmed with a 16 character description i.e., "Food", "Beverages", etc.
- Alpha display shows alpha descriptions in both program and register modes.
- Alpha keyboard cuts programming time in half! Program your own store name and commercial message - 9 lines by 24 characters each.
- 99 departments allow you to categorize merchandise to be sold. Each department can be programmed with a 16-character description.
- 1600 Price Look-Up (PLU) settings allow for fast, accurate entry of an item and records the number of items sold.
- 40 clerk numbers monitor sales of individual employees.
- Automatic tax computation available for 4 different tax rates, including add-on and VAT.
- Department-linked entry options that streamline and speed-up operation.
- Periodic management reports provide up-to-date sales analysis, including mid-day, end-of-day, weekly or monthly totals.
- Memory protection maintains financial records during power outage.
- Training mode available for new users.

The **ROYAL CONSUMER PRODUCT SUPPORT HOTLINE** gives you the opportunity to call for start-up assistance and problem resolution or for ordering supplies.

Customer Service (in U.S.A.): 1-800-272-6229 (or) +1-732-563-9944

Customer Service (in Canada): 1-888-266-9380

Customer Service (in Mexico): 01-800-849-4826

Ordering Supplies: 1-888-261-4555

Or visit our website for more information and troubleshooting at www.royal.com.

TABLE OF CONTENTS

UNPACKING YOUR CASH REGISTER and SET UP	1
Preparation	1
Standard Accessories	1
Initial Set Up	1
Maintenance of your Register	1
GETTING TO KNOW YOUR CASH REGISTER	2
Using the Manual	2
How to Get Started	2
BAR CODE SCANNER	2
SECURITY SYSTEM and ERROR CONDITIONS	3
5-way Security System	3
Error Conditions	3
CONTROL LOCK SYSTEM	4
The Control Lock	4
The Control Keys	4
Cash Drawer with Lock	4
KEYBOARD FUNCTIONS	5-7
DISPLAY WINDOWS	8
Operator Display	8
Customer Display	8
PRINTER	9
INSTALLING THE PAPER ROLL	10-11
Installing the Paper Roll for the Receipt	10
Installing the Paper Roll for the Journal	11
REMOVING THE PAPER ROLLS	12
To Remove the Paper Roll for the Receipt	12
To Remove the Paper Roll for the Journal	12
REPLACING THE BATTERY	13
QUICK START	14-15
AFTER QUICK START	16-17
Program Confirmation Report	16
BEFORE GOING TO REGISTER MODE	18
ADVANCED PROGRAMMING	19
CLERK NUMBERS	20-21
To Program Clerk Numbers	20
To Program a Clerk Name	20
To Use Clerk Numbers	21
MANAGER PASSWORDS	22
To Program the X Manager Passwords	22
To Program the Manager Password	22
DATE/TIME/MACHINE NUMBER	23
To Program the Date	23
To Program the Time	23
To Program the Machine Number	23
TAX RATES	24-27
To Program a Single Fixed Tax Rate	24
To Program a Second Fixed Tax Rate	24
Tax Table Rate	25
To Program a Single Tax Table Rate	25
To Program a Second Tax Table Rate	25
To Program a Third Tax Table Rate	26
VAT Tax Rate	27
Programming the VAT Tax Rate	27
To Programming a Second VAT Tax Rate	27
DEPARTMENT PROGRAMMING	28-32
To Program Department as Taxable	31
To Program Department as Non-Taxable	31
Department Programming for Department 21 to Department 99	32
COUPON DISCOUNT	33-35
To Program the Coupon [-/CPN] Key	35
MINUS PERCENTAGE DISCOUNT	36
PLUS PERCENTAGE	37
PRICE LOOK-UP (PLU)	38-39
To Program PLU's	38
To Search a Vacant PLU Number	39
To Delete PLU Data	39
TRAINING MODE	40
To Turn on the Training Mode	40
To Shut Off the Training Mode	40

TABLE OF CONTENTS (Continued)

GRAND TOTAL PRESET	41
To Set the Grand Total to Zero.....	41
To Assign a Value to the Grand Total.....	41
TRANSACTION NUMBER PRESET	42
To Program the Transaction Number.....	42
Rounding Method for Finalizing Amount.....	43
X1 and X2 COUNTER PRESET	44
To Program the X1 Counter Number.....	44
To Program the X2 Counter Number.....	44
Z1 and Z2 COUNTER PRESET	45
To Program the Z1 Counter Number.....	45
To Program the Z2 Counter Number.....	45
PROGRAMMING ALPHANUMERIC DESCRIPTIONS	46-51
Alpha Keyboard.....	46
To Input Character.....	46
Alphanumeric Code Chart.....	47
Wide Characters.....	48
PROGRAM STORE LOGO/COMMERCIAL MESSAGE	49-51
SCROLL MESSAGE	52
SCROLL MESSAGE SETTINGS	53
SCROLL MESSAGES PATTERN	54
TO PROGRAM THE TRANSACTION WORDS	55-58
FLAG OPTIONS	59-65
To Take a Flag Report.....	59
PROGRAM CONFIRMATION REPORTS	66-68
To Take a Program Confirmation Basic Preset Report.....	66
To Take a Clerk Confirmation Report.....	67
To Take a Department Report.....	68
PLU CONFIRMATION REPORT	69
To Take a PLU Confirmation Report.....	69
To Take a PLU Range Report.....	69
TRANSACTION EXAMPLES FOR OPERATING THE CASH REGISTER	70-86
Sample Receipt.....	70
Transaction Symbols.....	70
Example 1: Cash Sale Without Tendering Change.....	71
Example 2: Cash Sale With Tendering Change.....	71
Example 3: Using the Dept Shift Key and Tendering Change.....	71
Example 4: Charge Sale.....	72
Example 5: Check Sale.....	72
Example 6: Split Tendering Sale.....	72
Example 7: No-Sale Function.....	73
Example 8: Registering a Reference Number.....	73
Example 9: Multiplying by a Fraction.....	73
Example 10: Multiplication Sale.....	74
Example 11: Registering a Department Unit Price.....	74
Example 12: Multiplication of a Department Unit Price.....	74
Example 13: Department.....	75
Example 14: Exempting Tax on an Item.....	75
Example 15: Adding Tax to a Non-Taxable Department.....	75
Example 16: Received-On-Account Sale.....	76
Example 17: Paid-Out Sale.....	76
Example 18: Return Sale.....	76
Example 19: Coupon Discount Sale.....	77
Example 20: Minus Percentage Discount Sale.....	78
Example 21: Plus Percentage Sale.....	79
Example 22: Use of Error-Correct (EC) Key.....	80
Example 23: Voiding a Sale.....	80
Example 24: Voiding a Multiplication Sale.....	80
Example 25: Voiding a Coupon Sale.....	81
Example 26: Voiding a Minus Percentage Discount Sale.....	81
Example 27: Voiding a Plus Percentage Sale.....	81
Example 28: Voiding a Department Preset Price.....	82
Example 29: Voiding a Multiplication of a Department Preset Price.....	82
Example 30: Voiding a Department Preset with a Minus Percentage Discount.....	83
Example 31: Voiding a Department Preset with a Coupon Discount.....	83
Example 32: PLU Sale.....	84
Example 33: Voiding a PLU Sale.....	84
Example 34: Voiding a PLU Multiplication Sale.....	84
Example 35: Voiding a PLU Sale with a Coupon Discount.....	85

(Continued) TABLE OF CONTENTS

Example 36: Voiding a PLU Sale with a Minus Percentage Discount	85
Example 37: Voiding a PLU Sale with a Plus Percentage Rate	85
Example 38: Issuing a Duplicate Receipt	86
X/Z MANAGEMENT REPORTS	87-96
“X” Position Reading	87
“Z” Position Reading	87
Management Reports Available	87
Summary Management Reports	88-89
To Take a Cash-in-Drawer / Check-in-Drawer Report	90
To Take an Hourly Report	90
To Take a Department Range Report	91
To Take a Clerk Report	91
To Take an Individual Clerk Report	92
To Take a PLU Report	92
To Take a Cash Declaration Report	93
To Take a Group Report	94
To Take a Full Report	95
To Take a (Weekly or Monthly) Full Report	95
“Z1” Reading - Full Report Illustration	96
PC INTERFACE AND SOFTWARE	98
TROUBLESHOOTING	99
In Case of an Error Tone or if “E” Displays	99
If Printing Problems Occur	99
If Cash Register is Malfunctioning	99
Opening the Cash Drawer in an Emergency	99
Half System Clear Procedure	99
Full System Clear Procedure	99
SPECIFICATIONS and SAFETY	100-101
LIMITED WARRANTY	102
ACCESSORIES ORDER FORM	103
APPENDIX 1 - STATE TAX TABLE CODES	104-109
APPENDIX 2 - CALCULATING STATE TAX TABLE CODES	110-114
APPENDIX 3 - GST/PST FOR CANADA	115-116

UNPACKING YOUR CASH REGISTER and SET-UP

PREPARATION

When your cash register is new in its factory packaging, you will find the various items for the register packaged separately. Look for and unwrap the following: 2 paper rolls, black journal winder spindle, bar code reader, serial cable and duplicate key sets for the Control Lock and Cash Drawer Lock.

STANDARD ACCESSORIES

The following are included in the box with your cash register:

- Instruction manual
- (1) black plastic journal winder spindle
- (2) starter rolls of standard thermal paper tape (58mm), Royal Reorder Number (013127)
- (1) memory back-up battery (model CR-2032, 3-Volts) (already installed in the cash register)
- Bar Code Reader
- Serial Cable for PC Connection (9-pin serial connector on one end and RJ14 jack on the opposite end)
- Keys: (2) Cash Drawer Keys (515)
 - (2) Manager's Program Keys (MA, 33 I)
 - (2) Operator Register Keys (OP, 33 A)

IT IS IMPORTANT THAT YOU READ THE INITIAL SET-UP AND MAINTENANCE INSTRUCTIONS BEFORE ATTEMPTING TO OPERATE THE CASH REGISTER.

***** VERY IMPORTANT *****

You MUST INITIALIZE the cash register after unpacking it and plugging it in for the first time, before any programming or starting to use it. See Steps #6 and 7 below.

INITIAL SET UP

1. Locate on level surface - Before operating the cash register, be sure it is placed on a level surface to permits smooth operation of the register cash drawer.
2. This cash register operates on any standard three-hole electrical outlet (115-120 volt, 60 hertz). It is recommended that the cash register be connected to an electrical circuit where no other electrical device or appliance is connected which may overload the circuit or cause electrical interference with the cash register. It is best that a single circuit be provided for register operations.
3. Confirm the power switch located on the right hand corner of the cabinet to the "OFF" position.
4. Plug in the cash register. Insert Manager's Program Key (MA, 33 I) and turn to the "PRG" position.
5. Install paper - Refer to Page 10-11 for paper installation instructions.
6. Initialize the cash register by holding down the clear key and setting the power switch to the "ON" position.
7. Install the battery – Refer to Page 13. If Spanish, French or German is used instead of English, hold down the numeral 2, 3 or 4 key respectively instead of the clear key.

MAINTENANCE OF YOUR REGISTER

- Your register must remain uncovered when turned on; this will allow proper cooling of electronic components.
- Use a dust cover when the register is not in operation to protect mechanical components from dust.
- Take care to keep beverages and other liquids away from the machine to avoid spills which may damage electronic components (use optional protective keytop cover to prevent damage to machine).
- To clean, use a soft dry cloth. Do not use harsh solutions containing alcohol.
- Your machine should be kept in areas free from dust, dampness or extreme temperatures (hot or cold).
- After storage in extreme temperatures (below 32 degrees Fahrenheit or above 104 degrees Fahrenheit), allow the temperature inside the machine enough time to reach room temperature before switching on.
- Never pull the paper tape through the printhead. To prevent damage, always use the electronic paper feed key.
- Should electronic service be needed, a Royal authorized service center is recommended.

GETTING TO KNOW YOUR CASH REGISTER

USING THIS MANUAL

Your cash register manual is organized for easy reference. The front portion contains general information on all features and functions of the cash register. Instructions for setting the programs are next. Transaction examples for operating the register are at the back of the manual, along with information on troubleshooting. Use the TABLE OF CONTENTS to locate a particular section you are interested in.

Throughout this manual references to the Keypad are shown in bold and in parentheses. References to the Numeric Keypad are preceded by the word "**ENTER**"; for example: **ENTER** the number **(1)**. References to the Operational Keys are preceded by the word "**PRESS**"; for example: **PRESS** the **[AMOUNT TEND/TOTAL]** Key.

HOW TO GET STARTED

Before you begin to program or use your new Royal Cash Register, you should spend some time becoming familiar with the Control Lock System, Keyboard Functions and the Display. Review setting up and basic maintenance information. Then proceed by installing the paper roll. Follow the easy Quick Start program. Finish by practicing the transaction examples provided.

PROGRAMMING THE CASH REGISTER

Simple step-by-step instructions are provided to help you quickly program your register for standard operations. Please refer to the Quick Start programming on Pages 14 and 15.

OPERATING THE CASH REGISTER

Transaction examples are provided for registering various operations, such as cash, check, or charge sales; tendering change; multiple item sale; PLU sale; split tendering; voiding; refunding; discounting; coupon reduction and more. For details see Pages 70-86.

PROBLEMS WITH USAGE OF THE CASH REGISTER

If you are having technical difficulties or if your cash register is malfunctioning, refer to the Troubleshooting section on Page 99.

BAR CODE SCANNER

A bar code scanner is included with this cash register. The bar code scanner plugs directly into the cash register in the RJ45 ports on the right side of the cash register. The bar code scanner is "plug-and-play" and neither the bar code scanner nor the cash register need any additional or special programming.

Important Note: The bar code scanner should always be plugged in and connected or disconnected from the cash register while the Mode key of the cash register is in the "OFF" position. The cash register should only be turned "on" and to a specific mode after the bar code scanner or the serial cable to the PC is already connected to the cash register.

SECURITY SYSTEM and ERROR CONDITIONS

FIVE-WAY SECURITY SYSTEM: Your Royal cash register is protected by an efficient security system that incorporates the following:

- A Control Lock that cannot be activated without the Operator Register Key or Manager's Program Key. The Register Key accesses the "OFF" mode and "REG" modes only, thus limiting access to other modes only to individuals who are authorized to use the Manager's Program key.
- A heavy duty locking cash drawer.
- High digit lockout option which prevents excessively high register over rings.
- Availability of 40 clerk numbers to monitor access and sales of individual operators.
- 2-way Password system to prevent unauthorized programming or printing of management reports. A password can be programmed to limit access to "PRG", "X" and "Z" positions.
- A broad range of management reports to provide detailed data on virtually all cash register operations performed on the machine; monitors use of the "No Sale" key, number of voids, refunds, etc.

ERROR CONDITIONS

REGISTER TONE - This cash register emits a brief audible tone that sounds to confirm registration each time a key is pressed. If desired, this tone can be eliminated. See Flag # 69, Page 63.

ENTRY ERROR ALARM - When using the register, all operations must be performed in the proper sequence. If an error occurs, the register will sound a continuous tone alarm (a "KEY OP ERR" message appears in the display and the keyboard locks). To clear the error/lock condition, the operator simply **presses** the **[CLEAR]** key and continues to operate in the proper sequence. **IMPORTANT** - When an operation is begun but not completed in the "REG" position, turning the control lock to another position will result in an alarm/error condition. When a transaction is begun in the "REG" position, it must be completed by using of one of the totalizer keys (i.e., the [AMOUNT TEND/TOTAL] key before changing to another position.

MAXIMUM ENTRY LOCK-OUT - To prevent the operator from entering an erroneously high price into the register, the register can be programmed to limit the number of digits that can be entered in the transaction. The register can be programmed to "Lock-Out" after an entry of one (.09) to seven (99,999.99) digits.

CLEAR KEY [CLEAR] - As described above, the Clear [CLEAR] key will erase an alarm condition caused by an operational error (usually pressing a key which was not proper for that operation). The [CLEAR] key will not erase a transaction which has been registered by an operating key and printed on the register tape. To erase entries made in error after pressing the Department key or any other operating key causing the entry to be printed on the tape, use the Void [VOID] key function to correct the error.

ERROR - A "KEY OP ERR" message is displayed when a numerical entry exceeds the specified number of digits or a misoperation is done.

HALF SYSTEM CLEAR - If an error tone still persists, perform a Half System Clear. For details on a Half System Clear see Page 99.

FULL SYSTEM CLEAR - If the operator cannot correct an error lock condition, as a last resort a Full System Clear should be done. For details on the Full System Clear see Page 99.

CONTROL LOCK SYSTEM

THE CONTROL LOCK: Located at the right of the operating area, the Control Lock is a switch that places the cash register into its several operating modes. These modes are:

Program Mode (PRG): The position is used to set and change your individualized programming for register operations.

Locked Mode (OFF): This position is used when the cash register is not in use. The register is inoperable and the cash drawer stays closed.

Register Mode (REG): You will perform normal register operations in the REG position.

Report Mode (X): Permits reading of all transaction totals at any time without clearing the register (normally known as a "mid-day" reading). This cash register is capable of producing numerous management reports.

Reset Mode (Z): Permits reading of all transaction totals and clears all transaction totals to zero, except the running grand total (normally known as the "end-of-day" or "daily close-out" reading). This cash register is capable of producing numerous management reports such as weekly/monthly readings.

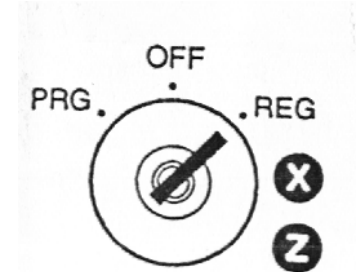

CONTROL KEYS: Two pairs of keys are provided for the Control Lock and the Cash Drawer Lock.

Operator's Register Key (OP): Provides movement to the OFF and REG modes only.

Manager's Key (MA): Provides access to all of the operating modes. This system effectively limits access to the PRG, X, and Z modes to individuals who are authorized to use the Manager's Program key only. (Note: A Manager Password is available for accessing "PRG", "X" and "Z" positions, for details see Page 22).

Cash Drawer Key (515): Used to lock the cash drawer for additional security.

CASH DRAWER WITH LOCK: The cash drawer will automatically open after completing a transaction by pressing the [# / ST / NS] key, or by the hidden emergency lever underneath the register.

The cash drawer is electronically locked when the Control Lock is in the "Off" position. In addition, the cash drawer is designed with a security lock and when used with the Cash Drawer key, manually locks the cash drawer and prevents electronically opening it by the [# / ST / NS] key or by the hidden emergency lever underneath the register.

The Bill Tray and Coin Tray can be removed from the register by lifting up on the open drawer and pulling toward you.

KEYBOARD FUNCTIONS

FIGURE 1: Control Lock and Keyboard Functions

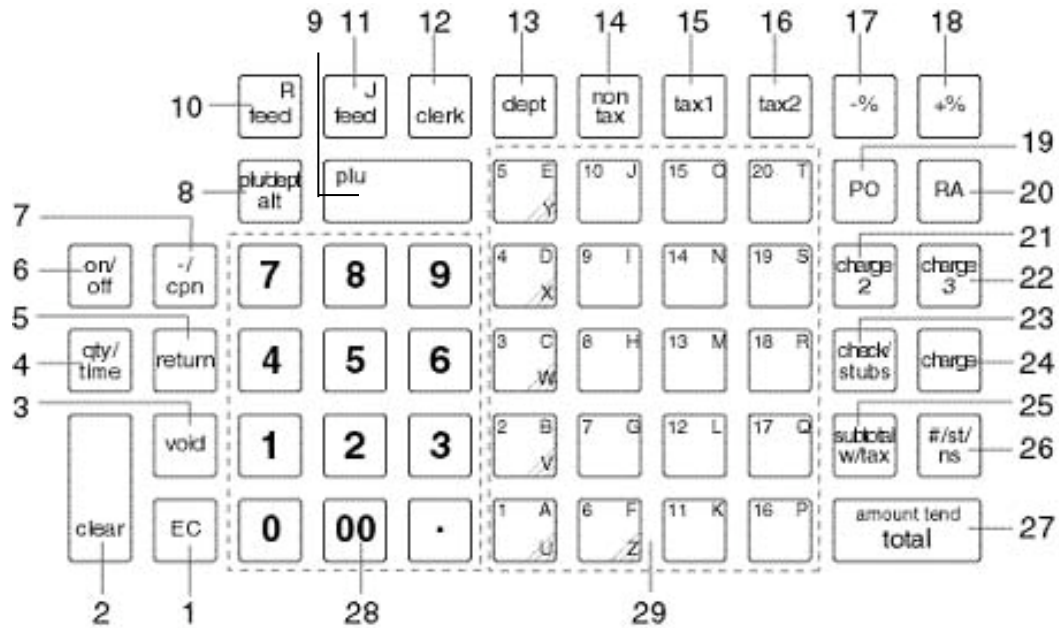

KEYBOARD FUNCTIONS

The following key functions are primarily for cash register entries in REG mode. Several keys also have other functions in the PRG, X and Z modes which are explained further in the manual.

- (1) **Error Correction [EC]** is used for deleting the last sales entry. It also functions as a back space and delete key when programming alpha characters.
- (2) **Clear Key [CLEAR]** clears the display to correct an entry before it is processed. Also stops error alarm when incorrect entries are made.
- (3) **Void [VOID]** is used for correcting a particular entry after it is processed and printed.
- (4) **Quantity and Time Key [QTY/TIME]** - double function - is used to multiply a number of items entered at one price and to display the current time.
- (5) **Return Key [RETURN]** is used for issuing refunds for returned merchandise.
- (6) **Receipt On/Off Key [ON/OFF]** allows you to turn off the receipt printing to save paper.
- (7) **Minus/Coupon Key [-/CPN]** is used to subtract a specific amount from an individual item. This is also known as a Mark-Down key.
- (8) **PLU Release Key [PLU/DEPT ALT]** is used to temporarily override a price which was preset to a PLU or department number.
- (9) **PLU Key [PLU]** allows the numbers from 1 to 1600 to be used as codes for pre-programming merchandise prices and to maintain a tally of cost and quantity of the merchandise sold.
- (10) **Receipt Feed Key [RF]** is used to advance the receipt paper.

KEYBOARD FUNCTIONS

- (11) **Journal Feed Key [JF]** is used to advance the journal paper.
- (12) **Clerk Key [CLERK]** is used for entering clerk numbers and the Manager's Password Code.
- (13) **Department Key [DEPT]** is used to make entries for departments 1 - 99. Press Department after each department number entry for departments 1 - 99.
- (14) **Non Tax Key [NON TAX]** is used when no tax is to be registered for a department that is programmed for tax.
- (15) **Tax 1 Key [TAX 1]** adds a tax amount to the sales figure according to the tax rate programmed for this key. Tax 1 key is normally used to program a single tax rate required by a particular area or state. It can also be used to override the pre-programmed tax on a department key.
- (16) **Tax 2 Key [TAX 2]** adds a tax amount to the sales figure according to the tax rate programmed for this key. Tax 2 key is normally used to program a second tax rate required by a particular area or state. It can also be used to override the pre-programmed tax on a department key.
- (17) **Minus Percentage Discount Key [-%]** is used to subtract a percentage rate such as an employee discount from an individual item. The rate can be pre-programmed or manually entered.
- (18) **Plus Percentage [+%]** is used to add a percentage rate such as a service charge or gratuity to an individual item. The percentage rate can be pre-programmed or manually entered.
- (19) **Paid-Out Key [PO]** is used to register dollar amounts taken out of the cash drawer that are not part of a sales transaction; i.e., petty cash.
- (20) **Received-On-Account Key [RA]** is used to register dollar amounts placed in the cash drawer that are not part of a sales transaction. Also used to register payments made to a customer's charge account or to declare the starting amount of cash in the drawer for the day.
- (21) **Charge 2 Key** is an extra Charge key.
- (22) **Charge 3 Key** is an extra Charge key.
- (23) **Check/Stub Key [CHECK/STUBS]** - double function - Check is used to finalize a transaction paid by a check. Stub is used to issue the stub receipt after the transaction has been finalized.
- (24) **Charge/Validation Key [CHARGE]** - double function - Charge is used to finalize a transaction paid by a credit card or can be used to denote an in-house charge. Valid is used to validate a check or charge form after the transaction has been finalized.
- (25) **Subtotal With Tax Key [SUBTOTAL W/TAX]** displays the total sales amount, including sales tax. It is not printed on the register receipt until the sale is finalized by pressing either the [CHECK/STUBS], [CHARGE] or the [AMOUNT TEND/TOTAL] key.
- (26) **Subtotal, No-Sale and Non-Add Key [#ST/NS]** - triple function - As the No-Sale key, it opens the drawer without registering any amounts; for example, to give change. The Non-Add key function allows entering up to a 7 digit reference number which prints on sales receipts. As the Subtotal key, it displays and prints the subtotal of a sale without sales tax.

KEYBOARD FUNCTIONS

- (27) **Amount Tendered/Total Key [AMOUNT TEND/TOTAL]** is used to finalize a transaction paid by cash and calculates the amount of change required from the cash received.
- (28) **Numeric Input Keys (0-9/00/.)** are used to input dollar amounts of merchandise sold, to indicate how many times a particular item repeats, to add and subtract percentages in conjunction with the -% and +% keys, to input PLU code numbers, to handle figures that require a decimal point and for other numeric value-related entries. Double Zero (00) allows for quick entry of numbers with two or more zeros. Decimal Point (.) is used to enter fractional quantity of items being sold. In all modes, the Decimal Point is not to be used when entering a price.
- (29) **Department Keys (1-20)** are used to specify which department the transaction is for. Each department can represent a category of merchandise sold and can be programmed as taxable or non-taxable.

Note: The department keys with letters are used in the program mode when programming alpha descriptions. To program the letters U, V, W, X, Y or Z, PRESS [DEPT] and enter 1, 2, 3, 4, 5 or 6.

LEAVING THE REGISTER PLUGGED IN: Keep the register plugged in and at the "OFF" (Locked) position when not in use. The keyboard is then inoperable and the cash drawer is electronically locked, but a minimum amount of power maintains the programs and transaction data totals.

DISPLAY WINDOWS

OPERATOR DISPLAYS

Your cash register provides two (10 digit capacity) displays, 1 line alpha and 1 line numeric, which feature large, easy to read fluorescent digits for easy operator viewing. The operator display is located at the top front of the machine and is your visual guide to the inner workings of the cash register. The numeric display shows entry amounts and related transaction information by the use of numbers and special symbols. The alpha display shows alpha prompts in both the Register and Programming modes.

Following is a graphic representation of the items shown on the cash register Operator Displays:

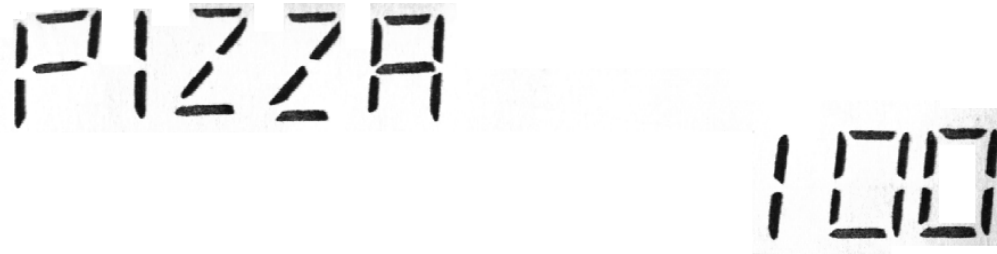

The display indicators read from left to right as follows:

NAME or CLERK 1 to 40:	Displays when the [CLERK] key is operated.
TAX 1/TAX 2:	Displays when the [TAX 1] or [TAX 2] key is operated.
NON TAX :	Displays when the [NON TAX] key is operated.
DEPT NUMBER or DESCRIPTION:	Displays the department number or description entered.
PLU NUMBER or DESCRIPTION:	Displays the number or description of the PLU entered.
CASH:	Displays when the [AMOUNT TEND/TOTAL] key is operated.
CHECK:	Displays when the [CHECK/STUBS] key is operated.
CHARGE:	Displays when the [CHARGE] key is operated.
CHARGE 2:	Displays when the [CHARGE 2] key is operated.
CHARGE 3:	Displays when the [CHARGE 3] key is operated.
CHANGE:	Displays the change due.
KEY OP ERR:	Displays if an error is detected. PRESS the [CLEAR] key to reset.
SUB-TTL:	Displays when the [# / ST / NS] key is pressed.
U:	Return symbol, appears when a void or return operation is performed.
R/A or P/O:	RA or PO symbol appears when an amount is entered and the RA or PO key is pressed.
VOID:	Displays when the [VOID] key is operated.
RCPT ON/OFF:	Displays when the ON/OFF key is pressed.
COUPON:	Displays when the [-/CPN] key is operated.
RETURN:	Displays when the [RETURN] key is operated.

CUSTOMER DISPLAY

To position the rear customer display, simply pull up and rotate for viewing from any direction. To close, simply turn the display facing away from you (to the rear of the cash register), then press down on the raised display until it lies flat against the top of the register.

The figure below shows the printer with the cover removed.

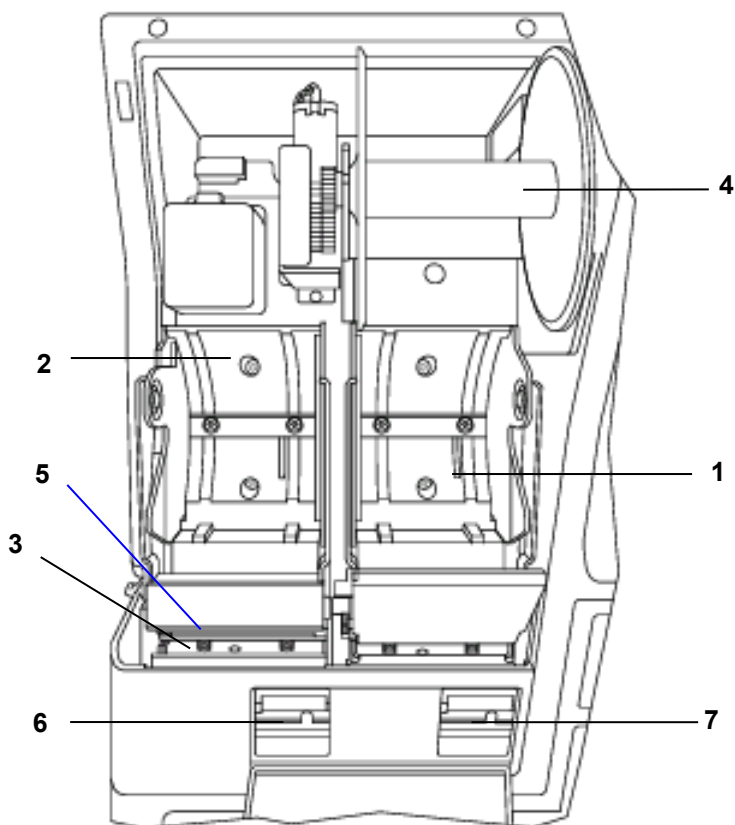

DESCRIPTION OF PART	FUNCTION
1. Journal location	The paper roll for record keeping (the journal) is located here.
2. Receipt location	The paper roll for receipts is located here.
3. Print-head unit	Prints the characters on the receipt and journal.
4. Take-Up Reel	Used to take up the paper used for record keeping (the journal).
5. Paper Exit	The paper exits here.
6. Platen Release Button (Receipt)	Release the platen for receipt.
7. Platen Release Button (Journal)	Release the platen for journal.

INSTALLING THE PAPER ROLLS

Your cash register features a thermal printer which uses two rolls of 58mm standard bond paper; one roll (left side) is for the customer receipt and the other roll is for the journal record (right side). If a customer receipt is not required, a paper saving option is available by pressing the [ON/OFF] key on the keyboard.

Before installing the paper roll, be sure to do the following to avoid causing a paper jam:

- a. Orient the paper roll so that it rotates in a counterclockwise direction, as shown in Fig. 1.

NOTE:

1. Thermal paper has a right and wrong side for printing. Install the paper roll correctly.
2. Be careful not to touch the paper cutter when removing the printer cover.

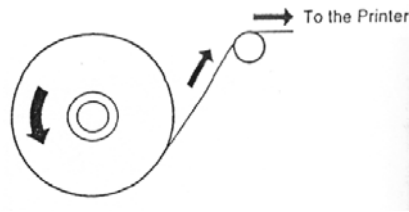

Fig.1

INSTALLING THE PAPER ROLL FOR THE RECEIPT

1. From the front of the cash register, take the rear of the printer cover and lift it up (See Fig. 2).
2. Push the platen release button (left) to raise the paper guide.
3. Load the paper roll into the receipt location, and put the paper end to this side.
4. Depress the paper guide (See Fig. 3).
5. Keep the paper guide to this end and close the printer cover.

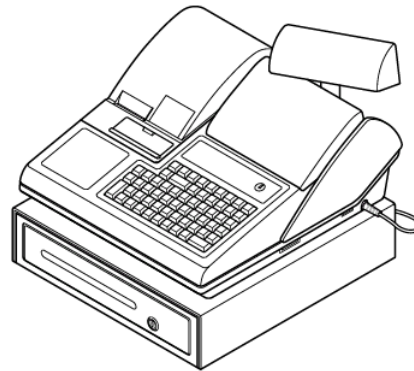

Fig.2

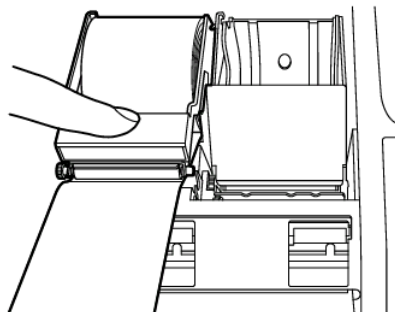

Fig.3

INSTALLING THE PAPER ROLL FOR THE JOURNAL

1. Make sure the Control Lock is in the “REG” (Register) position.
2. From the front of the cash register, take the rear of the printer cover and lift it up.
3. Push the platen release button (right) to raise the paper guide.
4. Load the paper roll into the journal location, and put the paper end to this side.
5. Depress the paper guide.
6. Insert the end into the slot in the take-up reel and wind two or three turns of paper around the reel (See Fig. 4).
7. Load the take-up reel into the support.
8. Press the J feed key (See Fig. 5).
9. Close the printer cover.

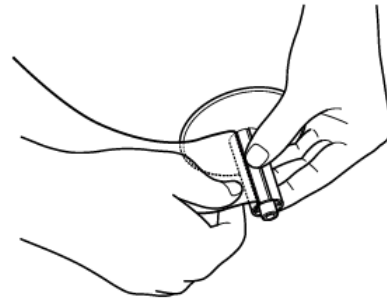

Fig.4

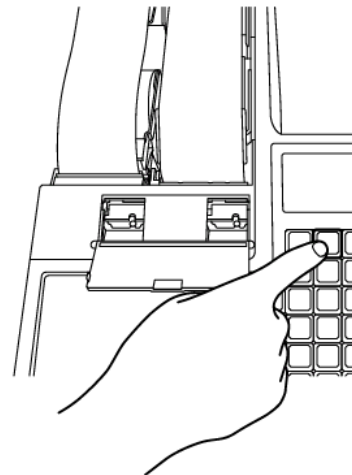

Fig.5

REMOVING THE PAPER ROLLS

TO REMOVE THE PAPER ROLL FOR THE RECEIPT

1. Open the printer cover.
2. Push the platen release button (left).
3. Remove the roll.

TO REMOVE THE PAPER ROLL FOR THE JOURNAL

1. Open the printer cover.
2. Push the platen release button (right).
3. Cut the paper after the end of the printing.
4. Remove the take-up spool from the support (See Fig. 6).
5. Remove the paper record for the take-up reel (See Fig. 7)
6. Install the remaining paper for the journal.
7. Close the printer cover.

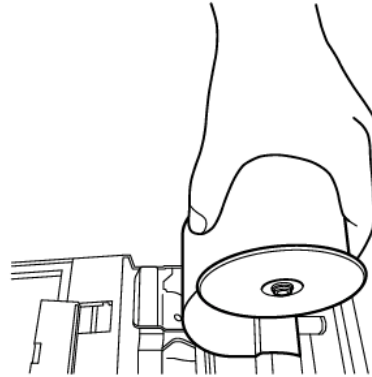

Fig.6

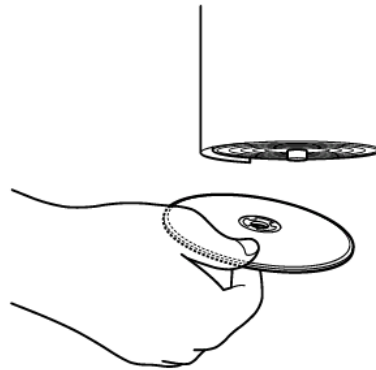

Fig.7

REPLACING THE BATTERY

1. Make sure the register is plugged in, the power switch is at "ON" position and turn the Control Lock key is turned to the "OFF position.
2. Open the printer cover.
3. Open the battery cover in the rear left section of the component (See Fig. 8).
4. Remove the old battery by pushing the small claw on the rear end of the battery (See Fig.9).
5. Put the new battery in the same position (See Fig. 10)
6. Close the battery cover and the printer cover.

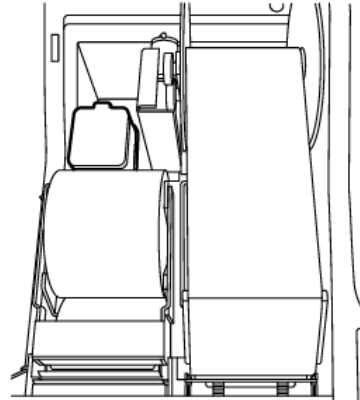

Fig.8

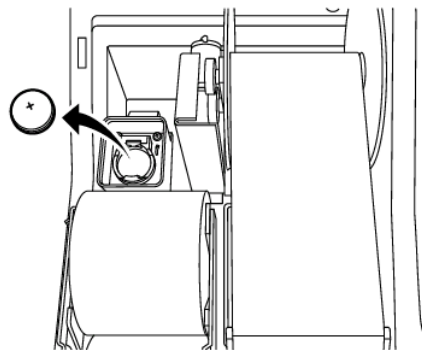

Fig.9

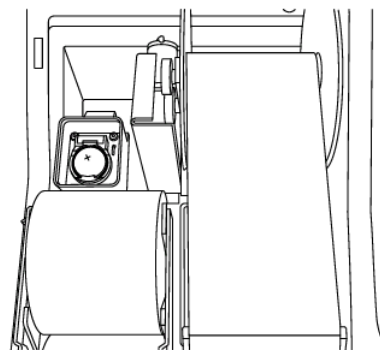

Fig.10

Battery: CR2032 (3-Volts)

QUICK START

The Quick Start program is designed to help you quickly "get started" with the basics you need to run your cash register. It covers programming the Decimal Point, Rounding, Date, Time, Tax Rate and Department Status for taxing or non-taxing. Follow the Quick Start straight through, however, skip any steps which are not required by your business needs. Once the Quick Start is completed, a Program Confirmation Report can be taken to review your results. As you go through the Quick Start, if an error tone sounds, **PRESS** the **[CLEAR]** key and continue by repeating the step you are attempting to program.

NOTE: It is not necessary to repeat the entire Quick Start program if you wish to update or change a step at any time. Therefore, maintain your owner's manual in a safe place for all future programming.

IMPORTANT: Before beginning the Quick Start, read Unpacking Your Cash Register and Set Up (Page 1), Getting To Know Your Cash Register (Page 2), Control Lock (Page 4), Keyboard Functions (Pages 5-7), Display Windows (Page 8), and Installing the Paper Roll (Pages 10-11).

FOLLOW THE QUICK START ON THE NEXT PAGE.

QUICK START: ROYAL ALPHA 9155SC

Before proceeding with Quick Start, the cash register must be initialized. Please see "Initial Set Up" on page 1.

1. Insert the Manager Program Key (MA) in the Control Lock and turn to the "PRG" program position.
2. To set the DATE, enter as month-day-year format. Example: For October 15, 2002:
ENTER (10152002), then **PRESS [#ST/NS]**.
3. To set the CURRENT TIME, use military time. Example: To set 10:15 A.M.:
ENTER (1015), then **PRESS [QTY/TIME]**.

* Reminder: To convert to military time, add the number 12 to every hour after 12:00 noon.
For example, to set 1:15 P.M. **ENTER (1315)**.
4. To set the TAX ROUNDING to the nearest whole number - U.S. standard:
ENTER (55), **PRESS [VOID]**.
5. To set a single fixed TAX RATE:
 - a) **ENTER TAX NO. , PRESS [TAX 1], ENTER the TAX RATE, PRESS [TAX 2], then PRESS [NON TAX]**.

Example: If Tax Rate is 5%: **ENTER (10), PRESS [TAX 1], ENTER (50000), PRESS [TAX 2], then PRESS [NON TAX]**.
 - b) If the Tax Rate is a decimal, for example 6.5%, program as follows:
ENTER (10) , PRESS [TAX 1], ENTER (65000), PRESS [TAX 2], then PRESS [NON TAX].

* Note: If you need to program a second or third tax rate, see Page 25-26 for details.
6. Departments can be programmed for the price, tax status and description all in one step. In order to get started quickly, we will program a price and tax status only. Complete setup is explained under Department Programming.
 - a) To program Department 1 as taxable and a price of \$1.00:
ENTER (1), PRESS [SUBTOTAL W/TAX], ENTER (100), PRESS [DEPARTMENT 1], then PRESS [CHECK/STUBS].

If no pre-set price is desired, skip entering the price.
 - b) To program Department 2 as non-taxable and a price of \$2.00:
ENTER (0), PRESS [SUBTOTAL W/TAX] , ENTER (200), PRESS [DEPARTMENT 2], then PRESS [CHECK/STUBS].

If no pre-set price is desired, skip entering the price.

(Continue to the next page)

AFTER QUICK START

Your tapes should look similar to the reports shown below. Note: The Date, Time, Tax Rate and Department Status will reflect the information based upon your input. If an error is made during programming, repeat only the step in question. For more details of the symbols printed in the reports see the complete examples of the reports starting on Page 70.

PROGRAM CONFIRMATION REPORTS

(Maintain the key in the "PRG" mode)

The **BASIC PRESET REPORT** prints out the date, time, store logo and commercial message information.

To print a Basic Preset Report, **ENTER (999999)**, then **PRESS the [AMOUNT TEND/TOTAL] key**.

***** YOUR RECEIPT Thank You Call again *****		# OF LOGO LINE	
	BASIC PRESET	PROGRAMMED	LOGO LINE 5
FLAG OP	1-10 1020000000	1st LOGO LINE	LOGO 1
	11-20 0000000000		*****
	21-30 0000000000	2nd LOGO LINE	LOGO 2
	31-40 0000000000	3rd LOGO LINE	YOUR RECEIPT
	41-50 0000000000	4th LOGO LINE	LOGO 3
	51-60 0000000000	5th LOGO LINE	Thank You
	61-70 0000000000	6th LOGO LINE	Logo 4
	71-80 0010010200	7th LOGO LINE	Call Again
	81-90 0000000000	8th LOGO LINE	Logo 5
		9th LOGO LINE	*****
TAX-1	0		LOGO 6
	0.0000%		LOGO 7
	@0.00		LOGO 8
TAX-2	0	# OF MESSAGE LINE	LOGO 9
	0.0000%		MESSAGE LINE 0
	@0.00		MESSAGE 1
TAX-3	0	1-9 MESSAGE LINES	MESSAGE 2
	0.0000%		MESSAGE 3
	@0.00		MESSAGE 4
TAX-4	0		MESSAGE 5
	0.0000%		MESSAGE 6
	@0.00		MESSAGE 7
			MESSAGE 8
			MESSAGE 9
COUPON FLAG	COUPON F 0000	SCROLL MESSAGE #1-4	SCR TBM 1 01
COUPON AMOUNT	COUPON 0.00	DISPLAY TIME	SCR TBM 2 10
MINUS % FLAG SETTING	-% F 00		SCR TBM 3 10
MINUS % DISCOUNT	-% 0.00%		SCR TBM 4 10
PLUS % FLAG SETTING	+% F 00	TIME DISPLAY	T DISPLY 2
PLUS % DISCOUNT	+% 0.00%	SCROLL FLAG	SCR FLAG 0
TRANSACTION NUMBER	CSCN 0001	SCROLL SPEED	SCR SPD 2
MACHINE #	MCNO 00		SCR1 CLOSED, NEXT REGIS
ROUNDING	ROUND 0000	SCROLL MESSAGE #1-5	TER PLEASE
	X1CNT 0001		SCR2 PLEASE WAIT
REPORT COUNTERS	X2CNT 0001		SCR3 PLEASE TAKE YOUR R
	Z1CNT 0001		ECEIPT
	Z2CNT 0001		SCR4 GOOD MORNING
PROGRAM PASSWORD	PROGRAM 0000		SCR5 GOOD AFTERNOON
REPORT PASSWORD	REPORT 0000		
GRAND TOTAL	NRGT 0.00		

(Continued) AFTER QUICK START

The **DEPARTMENT PRESET REPORT** prints department descriptions, price and tax status. To print a Department Report, **PRESS [PLU/DEPT ALT] followed by any [DEPARTMENT] key.**

DEPT PRESET		
01	DEPT01	DEPARTMENT NO. / DESCRIPTIONS.
	PRICE	1.00
	FLAG	0000000001
02	DEPT02	DEPARTMENT NO. / DESCRIPTIONS
	PRICE	2.00
	FLAG	0000000000
03	DEPT03	DEPARTMENT STATUS (NON TAXABLE)
	PRICE	0.00
	FLAG	0000000000
04	DEPT04	DEPARTMENT NO. / DESCRIPTIONS
	PRICE	0.00
	FLAG	0000000000
05	DEPT05	DEPARTMENT NO. / DESCRIPTIONS
	PRICE	0.00
	FLAG	0000000000
06	DEPT06	DEPARTMENT NO. / DESCRIPTIONS
	PRICE	0.00
	FLAG	0000000000
07	DEPT07	DEPARTMENT NO. / DESCRIPTIONS
	PRICE	0.00
	FLAG	0000000000

Time Display: PRESS the [QTY/TIME] key in the register mode to show the time. The time display does not need to be canceled because it is automatically replaced by a figure when the next transaction is performed. The [QTY/TIME] key is a double function key where, during a transaction, it is used to perform multiplication when a quantity of more than one is registered.

BEFORE GOING TO THE REGISTER MODE

Your Royal cash register offers many additional features not covered in the Quick Start programming. Please note that all programming options are covered in the Advanced Programming section of this manual, even those singled out for use in the Quick Start. Please review a few of the additional programming options available on this register described below which you may choose to review or add to your basic Quick Start set up. For quick reference, the page numbers are noted by each feature presented:

TRAINING MODE (Page 40): Designed to help you get acquainted with the register mode and allows a place for practicing transaction examples without effecting machine totals. Since the Training Mode does not record any transactions performed while in the register mode, it is ideal for beginners.

TRANSACTION EXAMPLES (Pages 70-86): Simple transaction examples are provided for use in the register mode. This section will cover a cash sale, check sale, charge sale, tendering change, multiple items, PLU sale, split tendering, voiding, as well as other frequently used functions. Be sure to have the key in the "REG" (register) mode when following the transaction examples. **Suggestion: Practice the transaction examples after activating the Training Mode described above.**

CLERK NUMBERS AND NAMES (Page 20-21): Clerk numbers can be used to monitor sales of 40 individual employees with clerk names.

MANAGER PASSWORDS (Page 22): A password can be assigned for the "PRG", "X" and "Z" modes.

FLAG OPTIONS (Pages 59-65): A total of 90 system programming options are offered on this cash register. They are preset by the factory to accommodate many of the most commonly used selections. These options can be changed to meet your individual needs.

ADVANCED PROGRAMMING

The options covered in the Advanced Programming section are designed to let you customize your cash register operations, sales entry printouts, and management reports to meet your individual business requirements. The Advanced Programming can be used to further add options not covered by the Quick Start Program. Skip any or all sections which are not required in setting up your cash register. Note: During programming, if an error tone sounds, **PRESS** the **[CLEAR]** key, then continue by repeating the step you are attempting to program.

Note: It is not necessary to reprogram all options when you wish to update or change a step at any time. Therefore, maintain your owner's manual in a safe place for all future programming.

The programming of the cash register consists of the following features:

Clerks Numbers and Names	Grand Total Preset
Manager Passwords (PRG and X/Z)	Transaction Number Preset
Date	X1 and X2 Counter Preset
Time Clock	Z1 and Z2 Counter Preset
Machine Number	Void and Return Functions
4 Tax Rates	Flag Options
Department	Rounding
Coupon Discount (-/CPN)	Programming Confirmation Reports
Minus Percentage Discount (-%)	PLU Confirmation Report
Plus Percentage (+%)	Management Reports (X/Z)
Price Look-Up (PLU)	

Once programming is completed, there are several Confirmation Reports available to check your results:

- Basic Pre-set Report lists all flag options, shows date, time, machine number, passwords, store logo and commercial messages programmed.
- Tax rate and tax table codes.
- Department Confirmation Report: lists Department Settings programmed.
- PLU Program Confirmation Report: lists all PLUs that are programmed.
- Clerk Confirmation Report listing Clerk ID Numbers and Names, Manager Password Numbers and X/Z Counter Beginning Numbers.

CLERK NUMBERS

A total of 40 Clerk Numbers are available for monitoring sales of individual employees. Each Clerk Number can be programmed with a 24 character name (this procedure is covered in the section Programming Alphanumeric Descriptions on Page 46-51). The Clerk Numbers are designed to be used in the REGISTER modes only. To obtain sales totals of each clerk, a Clerk Report is available in both the "X" and "Z" modes. Extra Security Option: If desired, a procedure is offered to require entry of a Clerk Number before every transaction, for details see Flag 18, Page 60.

TO PROGRAM CLERK NUMBERS

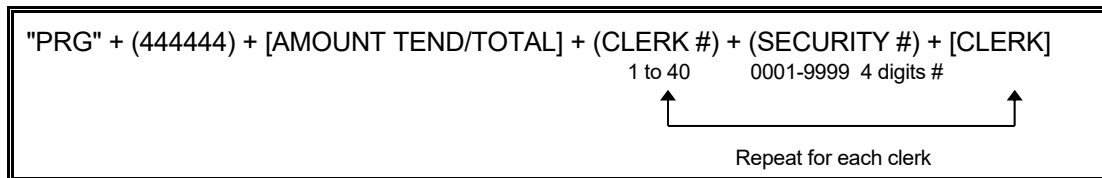

Example: For Clerk #1, Security # is 234:

1. Turn the key to the "PRG" (PROGRAM) position.
2. If a PRG/Z manager password has been programmed, TYPE the (PASSWORD #), then PRESS the [CLERK] key, or if you did not program a PRG/Z manager password, go to Step 3.
3. ENTER (444444), then PRESS the [AMOUNT TEND/TOTAL] key.
4. ENTER (1) for Clerk #1, then ENTER (0234) for the Security # and PRESS the [CLERK] key.
5. Repeat Step 4 for programming Clerks 2 through 40.
6. When programming Clerk Numbers is complete, you must first activate the Clerk System by selecting (Flag 16). This option will tell you to do the following: ENTER (16)(1), then PRESS the [VOID] key.

NOTE: If a mistake occurs during the programming of the Clerk Numbers, PRESS the [CLEAR] key and begin again with Step 3.

TO PROGRAM A CLERK NAME

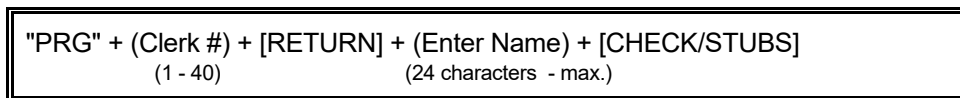

↑
(Alphabet can be input through department keys)

Example: For Clerk #1, program name as Sally Smith:

1. Turn the key to the "PRG" (PROGRAM) position.
2. If a PRG/Z manager password has been programmed, TYPE the (PASSWORD #), then PRESS the [CLERK] key, or if you did not program a PRG/Z manager password, go to Step 3.
3. ENTER (1) for Clerk #1, then PRESS the [RETURN] key.
4. Input name, up to 24 characters, using the alpha keyboard (Department keys) or Alphanumeric Code Chart (see Page 45). Remember, the Department Shift key accesses the letters in the lower green section of the Department keys. As you enter the name, the characters appear on the display. If you need a space to separate the first name and last name, use the code (0, 0) to program the space.
5. PRESS the [CHECK/STUBS] key to finalize.

NOTE: By setting the Flag 16, the clerk function can come into use.

TO USE CLERK NUMBERS

"REG" + [CLERK #] + [CLERK]
4 digit #

Example: If Clerk #1 is 4456:

1. **Turn the key to the "REG" (REGISTER) position.**
2. **ENTER (4456)**, then **PRESS** the **[CLERK]** key.
3. The cash register is now ready for operation.

NOTE: The Clerk Name will print on the receipt tape. If no name has been programmed, the clerk number will print on the receipt.

MANAGER PASSWORDS

Two Manager Passwords are available as an added measure; one password accesses only the "PRG" (PROGRAM) and "Z" modes and the second accesses only the "X" mode. The Manager Password resets every time it is used, therefore once a password has been programmed, it must be entered every time you access the program mode or before every "X" or "Z" reading is taken.

TO PROGRAM THE "X" MANAGER PASSWORD

CAUTION: Please write your passwords down in a safe place. If the passwords are forgotten, a FULL SYSTEM CLEAR procedure will be necessary. A Full System Clear will erase all transaction data and programming. For details on the Full System Clear see Page 99.

"PRG" + (222222) + [AMOUNT TEND/TOTAL] + (MANAGER PASSWORD #) + [NON TAX]
4 digit #

Example: If the "X" password is 1212:

1. Turn the key to the "PRG" (PROGRAM) position.
2. ENTER (222222), then PRESS the [AMOUNT TEND/TOTAL] key.
3. ENTER (1212), then PRESS the [NON TAX] key.

TO PROGRAM THE "PRG/Z" MANAGER PASSWORD

CAUTION: Please write your passwords down in a safe place. If the passwords are forgotten, a FULL SYSTEM CLEAR procedure will be necessary. A Full System Clear will erase all transaction data and programming. For details on the Full System Clear see Page 99.

"PRG" + (111111) + [AMOUNT TEND/TOTAL] + (MANAGER PASSWORD #) + [NON TAX]
4 digit #

Example: If the "PRG/Z" password is 1313:

1. Turn the key to the "PRG" (PROGRAM) position.
2. ENTER (111111), then PRESS the [AMOUNT TEND/TOTAL] key.
3. ENTER (1313), then PRESS the [NON TAX] key.

TO USE THE MANAGER PASSWORD

"PRG" or "X" or "Z" + (MANAGER PASSWORD #) + [CLERK]
4 digit #

- A. Example: Access the "X" mode, the Manager Password is 1212:
1. Turn the key to the "X" mode.
 2. ENTER (1212), then PRESS the [CLERK] key.
 3. You are now ready to take an "X" Report.
- B. Example: Access the PRG/Z modes, the Manager Password is 1313:
1. Turn the key to the "PRG" (PROGRAM) or "Z" mode as needed.
 2. ENTER (1313), then PRESS the [CLERK] key.
 3. You are now ready to program or take any reports based on your selection in Step 1.

The **DATE** is designed to roll over automatically every day and prints in the month-day-year format. Extra Option: If desired, a procedure is offered to eliminate the date from printing on the transaction receipts, for details see Flag 24, on Page 61. The date format can also be changed to print day-month-year (see Flag 1, Page 59.)

TO PROGRAM THE DATE

"PRG" + (MONTH-DAY-YEAR) + [# / ST / NS]
8 digit #

Example: To program January 24, 2005:

1. Turn the key to the **"PRG" (PROGRAM)** position.
2. If a PRG/Z Manager Password has been programmed, **TYPE** the **(PASSWORD #)**, then **PRESS** the **[CLERK]** key, or if you did not program a PRG/Z Manager Password, go to Step 3.
3. **ENTER (01242005)**, then **PRESS** the **[# / ST / NS]** key.

The **TIME** is designed to use military time. REMINDER: To convert to military time, add the number 12 to every hour. Example: 1:15 P.M. will program as (1315). Extra Option: If desired, a procedure is offered to eliminate the time from printing on transaction receipts, for details see Flag 23, on Page 61.

TO PROGRAM THE TIME

The time can print in either the 12 or 24 hour format. The default setting is to print in the 12 hour mode which is the preferred U.S. setting. To change to the 24 hour format, see Flag 2 on Page 59.

"PRG" + (HOUR, MINUTES) + [QTY / TIME]
4 digit #

Example: To program 10:15 A.M.:

1. Turn the key to the **"PRG" (PROGRAM)** position.
2. If a PRG/Z Manager Password has been programmed, **TYPE** the **(PASSWORD #)**, then **PRESS** the **[CLERK]** key, or if you did not program a PRG/Z Manager Password, go to Step 3.
3. **ENTER (1015)**, then **PRESS** the **[QTY / TIME]** key.

The **MACHINE NUMBER** is designed to assign each cash register its own identifying number. The Machine Number prints on all receipts/journal records, and management reports.

TO PROGRAM THE MACHINE NUMBER

"PRG" + (2) + (MACHINE #) + [PO]
4 digit #

Example: Program the cash register number to be 1234:

1. Turn the key to the **"PRG" (PROGRAM)** position.
2. If a PRG/Z Manager Password has been programmed, **TYPE** the **(PASSWORD #)**, then **PRESS** the **[CLERK]** key, or if you did not program a PRG/Z Manager Password, go to Step 3.
3. **ENTER (2),(1234)**, then **PRESS** the **[PO]** key.

Confirmation Report: To check your results, a Program Confirmation Report is available. For details see Pages 66-69.

TAX TABLE RATE

Refer to Appendix 1 to locate the tax table codes listed for your particular state. If your state's tax rate is not listed in Appendix 1, refer to Appendix 2 for instructions on calculating your own state's tax table codes.

Remember: Tax 1, Tax 2 and Tax 3 can be programmed with a Tax Table Rate.

Important: Step 1, on Page 25 must be completed before programming the Tax Table Rate.

TO PROGRAM A SINGLE TAX TABLE RATE

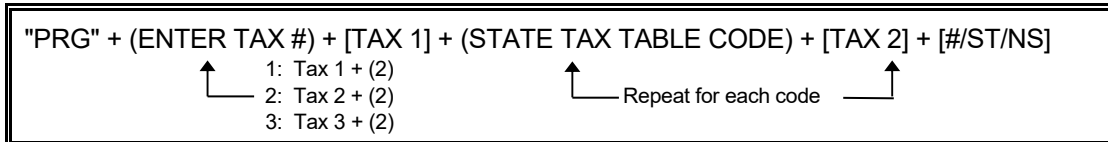

Example: The tax code for Arizona's tax rate of 4% is: 138-100-4-13-19-23-27-27-29-25-25-25-25.

To program this under Tax 1, which you must have previously defined as a Tax Table Rate per the instructions in Step 1:

1. Turn the key to the "PRG" (PROGRAM) position.
2. If a Manager Password has been programmed, ENTER the (PASSWORD #), then PRESS the [CLERK] key, or if you did not program a Manager Password, go to Step 3.
3. ENTER (12), then PRESS [TAX 1] key.
4. ENTER (138), then PRESS the [TAX 2] key.
5. ENTER (100), then PRESS the [TAX 2] key.
6. Continue typing the State Tax Table Codes and PRESS the [TAX 2] key after each code until finished.
7. When finished, PRESS the [#ST/NS] key to finalize.

NOTE: If a mistake occurs during programming the State Tax Table Codes, PRESS the [CLEAR] key and begin again with Step 3.

TO PROGRAM A SECOND TAX TABLE RATE

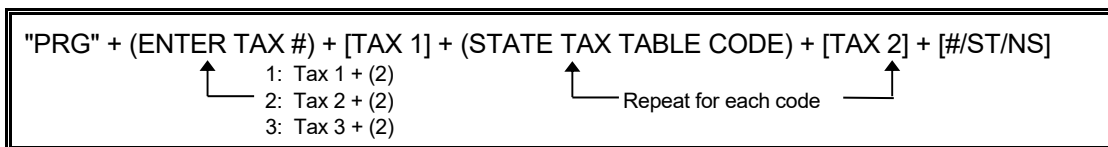

Example: The tax code for Arizona's tax rate of 5% is: 90-100-5-11-17-20-21-21-20-20-20-20-20.

To program this under Tax 2, follow the instructions in Step 1 to designate Tax 2 as a Table Tax and then:

1. Turn the key to the "PRG" (PROGRAM) position.
2. If a Manager Password has been programmed, ENTER the (PASSWORD #), then PRESS the [CLERK] key, or if you did not program a Manager Password, go to Step 3.
3. ENTER (22), then PRESS [TAX 1] key.
4. ENTER (90), then PRESS the [TAX 2] key.
5. ENTER (100), then PRESS the [TAX 2] key.
6. Continue typing the State Tax Table Codes mentioned and PRESS the [TAX 2] key after each code until finished.
7. When finished, PRESS the [#ST/NS] key to finalize.

NOTE: If a mistake occurs during programming the State Tax Table Codes, PRESS the [CLEAR] key and begin again with Step 3.

TAX RATE (Continued)

TO PROGRAM A THIRD TAX TABLE RATE

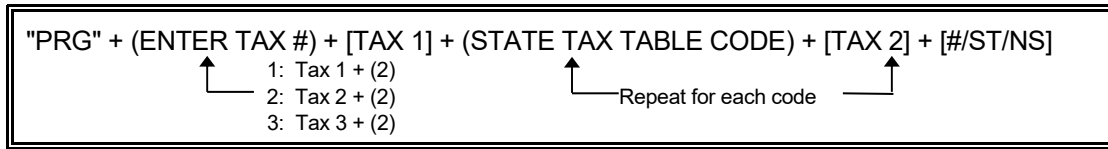

Example: The tax code for Arizona's tax rate of 5% is: 90-100-5-11-17-20-21-21-20-20-20-20-20.

To program this under Tax 3, follow the instructions in Step 1 to designate Tax 3 as a Table Tax and then:

1. Turn the key to the "PRG" (PROGRAM) position.
2. If a Manager Password has been programmed, ENTER the (PASSWORD #), then PRESS the [CLERK] key, or if you did not program a Manager Password, go to Step 3.
3. ENTER (32), then PRESS [TAX 1] key.
4. ENTER (90), then PRESS the [TAX 2] key.
5. ENTER (100), then PRESS the [TAX 2] key.
6. Continue typing the State Tax Table Codes mentioned and PRESS the [TAX 2] key after each code until finished.
7. When finished, PRESS the [#ST/NS] key to finalize.

NOTE: If a mistake occurs during programming the State Tax Table Codes, PRESS the [CLEAR] key and begin again with Step 3.

Confirmation Report: To check your results, a Confirmation Report of Tax Table Codes is available. For details see Page 66.

VAT TAX RATE (commonly used in Europe)

1. Turn the key to the "PRG" (PROGRAM) position.
2. If a PRG/Z Manager Password has been programmed, TYPE the (PASSWORD #), then PRESS the [CLERK] key, or if you did not program a PRG/Z Manager Password, go to Step 3.

PROGRAMMING THE VAT TAX RATE:

"PRG" + (TAX #) + [TAX 1] + (TAX RATE) + [TAX 2] + (TAX EXEMPT LIMIT AMOUNT) + [NON TAX]		
1-4	0 - 99.9999%	6 digit #
	TAX 1 = VAT 1 + (1)	
↑	TAX 2 = VAT 2 + (1)	
	TAX 3 = VAT 3 + (1)	
	TAX 4 = VAT 4 + (1)	

Example: 10% Tax Programming.

1. Turn the key to the "PRG" (PROGRAM) position.
2. If a PRG/Z Manager Password has been programmed, ENTER the (PASSWORD #), then PRESS the [CLERK] key, or if you did not program a PRG/Z Manager Password, go to Step 3.
3. ENTER (11), PRESS the [TAX 1] key, ENTER (100000), then PRESS the [TAX 2] key.
4. ENTER (TAX EXEMPT LIMIT AMOUNT), then PRESS the [NON TAX].

TO PROGRAM A SECOND VAT TAX RATE:

Example: 5%

1. Turn the key to the "PRG" (PROGRAM) position.
2. If a PRG/Z Manager Password has been programmed, ENTER the (PASSWORD #), then PRESS the [CLERK] key, or if you did not program a PRG/Z Manager Password, go to Step 3.
3. ENTER (21), PRESS the [TAX 1] key, ENTER (50000), then PRESS the [TAX 2] key.
4. ENTER (TAX EXEMPT LIMIT AMOUNT), then PRESS the [NON TAX].

DEPARTMENT PROGRAMMING

A maximum of 99 Departments are available on your cash register. Each department can represent a category of merchandise. For example, Department One can represent sales of beverages, Department Two sandwiches, Department Three candy, etc. Each Department can be programmed as taxable or non-taxable.

The programming of departments consists of ten steps: selecting the Standard or Food Stamp Function, selecting the Standard or Hash Function, selecting the Standard or Gallonage Function, selecting Negative Department Function, selecting Multiple / Single Entry, selecting the Group Number, selecting the High Digit Lock Out (HDLO) Number, assigning a Tax Status Number, assigning a Department Preset price, and Plus Programming a Department Description, if desired.

"PRG" + (Standard/Food Stamp Dept.) + (Standard/Hash Dept.) + (Standard/Gallonage Dept.) +
1 digit #
1 digit #
1 digit #
(Standard/Negative Dept.) + (Multiple/Single Entry) + (Group #) + (HDLO #) + (Tax Status #) +
1 digit #
1 digit #
1 digit #
1 digit #
2 digit #
[SUBTOTAL W/TAX] + (Pre-set Price or "0") + [DEPARTMENT NUMBER] + (Description) + [CHECK/STUBS]
8 digit #
16 characters(maximum)

NOTE: **[SUBTOTAL W/TAX], [DEPARTMENT NUMBER], [CHECK/STUBS]**

When these keys are operated without number or description entry, the flags, prices and names that have already been programmed are not changed.

- FOOD STAMP:** Each department can be set for either Standard Mode or Food Stamp Mode. Food Stamp Mode can represent sales of food stamp (or coupon) items for livelihood assistance by the government.

<u>Number</u>	=	<u>Condition</u>
0	=	Standard Department
1	=	Food Stamp Department

- HASH:** Hash departments represent sales of items on consignment.

<u>Number</u>	=	<u>Condition</u>
0	=	Standard Department
1	=	Hash Department

- STANDARD/GALLONAGE DEPARTMENT:** Each department can be set for either Standard Mode or Gallonage Mode. Gallonage Mode allows the entry of a price with 3 decimal places, representing the cost per gallon, i.e., 1.419 per gallon. Standard Mode enters the price using the normal 2 decimal place setting.

<u>Number</u>	=	<u>Condition</u>
0	=	Standard Department
1	=	Gallonage Department

- NEGATIVE DEPARTMENT:** Each department can be programmed with a negative (minus) value.

<u>Number</u>	=	<u>Condition</u>
0	=	Standard Department
1	=	Negative Department

(Continued) **DEPARTMENT PROGRAMMING**

5. **MULTIPLE ITEM/SINGLE ITEM:** Multiple Item Entry allows you to ring up two or more items into a department. Single Item Entry allows you to ring up only one item in a department.

<u>Number</u>		<u>Condition</u>
0	=	Multiple Item Sale
1	=	Single Item Sale

6. **GROUP NUMBER:** Each department can be classified in up to nine groups. For example, group departments 1, 2 and 3 designate as Group 1, which represents the total beverage sales.

<u>Number</u>	<u>Grouping Category</u>
0	0
1	1
2	2
3	3
4	4
5	5
6	6
7	7
8	8
9	9

7. **THE HIGH DIGIT LOCK OUT (HDLO):** number is used to limit the number of digits that can be rung up in an entry. This function is helpful in safeguarding against large over rings. If an excess number of digits is entered, the error tone sounds and the keypad locks up. For example, to limit ring ups of more than \$99.99, set the HDLO to 4.

<u>Number</u>		<u>Dollar Range</u>	
0	=	\$.01	- \$99,999.99 (Standard Setting)
1	=	.01	- .09
2	=	.01	- .99
3	=	.01	- 9.99
4	=	.01	- 99.99
5	=	.01	- 999.99
6	=	.01	- 9,999.99

(Department Programming continues on the next page)

DEPARTMENT PROGRAMMING (Continued)

8. **THE TAX STATUS** is used to link no tax, a single tax rate [Tax 1] or multiple tax rates (Tax 2, 3 or 4) to a department key.

<u>Tax Status Number</u>		<u>Condition</u>
00	=	Non-Taxable (used when you do not wish to charge tax)
01	=	Taxable by Tax Rate 1
02	=	Taxable by Tax Rate 2
03	=	Taxable by Tax Rate 1 and Tax Rate 2
04	=	Taxable by Tax Rate 3
05	=	Taxable by Tax Rate 1 and Tax Rate 3
06	=	Taxable by Tax Rate 2 and Tax Rate 3
07	=	Taxable by TAX 1, TAX 2 and TAX 3 Rates
08	=	Taxable by Tax Rate 4
09	=	Taxable by Tax Rate 1 and Tax Rate 4
10	=	Taxable by Tax Rate 2 and Tax Rate 4
11	=	Taxable by TAX 1, TAX 2 and TAX 4 Rates
12	=	Taxable by Tax Rate 3 and Tax Rate 4
13	=	Taxable by TAX 1, TAX 3 and TAX 4 Rates
14	=	Taxable by TAX 2, TAX 3 and TAX 4 Rates
15	=	Taxable by TAX 1, TAX 2, TAX 3 and TAX 4 Rates

9. **DEPARTMENT PRESET PRICE:**

NOTE: Department Preset Price is used to program a price in a department to save time when ringing up an entry. The price will automatically ring up each time the appropriate [DEPARTMENT] key is pressed.

10. **DEPARTMENT NAME:** A name or description can be assigned to each department key. This name will display and print when ringing up sales. For example, "Clothing" will print on the receipt in place of "Dept 1"; "Shoes" in place of "Dept 2"; "Sportswear" in place of "Department 3", etc.

(Department Programming continues on the next page)

TO PROGRAM DEPARTMENTS AS TAXABLE

<p>"PRG" + (Standard/Food Stamp Dept.) + (Standard/Hash Dept.) + (Standard/Gallonage Dept.) + 1 digit # 1 digit # 1 digit # (Standard/Negative Dept.) + (Multiple/Single Entry) + (Group #) + (HDLO #) + (Tax Status #) + 1 digit # 1 digit # 1 digit # 1 digit # 2 digit # [SUBTOTAL W/TAX] + (Pre-set Price or "0") + [DEPARTMENT NUMBER] + (Description) + [CHECK/STUBS] 8 digit # 16 characters(maximum)</p>
--

Example: Program Department 1 to charge a single tax rate (TAX 1); HDLO of "0" and Multiple Entry and preset price of \$1.00:

1. Turn the key to the "PRG" (PROGRAM) position.
2. If a PRG/Z Manager Password has been programmed, TYPE the (PASSWORD #), then PRESS the [CLERK] key, or if you did not program a PRG/Z Manager Password, go to Step 3.
3. ENTER (1), PRESS the [SUBTOTAL W/TAX] key.
4. ENTER (100), then PRESS the [DEPARTMENT 1] key. If you do not wish to preset a price, you must enter "0", then PRESS [DEPARTMENT 1]. You only need to continue with Steps 5 and 6 if you wish to program a department description. If not, you can stop after completing Step 4 by pressing the [CHECK/STUBS] key.
5. To program a description, begin inputting characters using the alpha keyboard (Department keys) or the Alphanumeric Code Chart if needed (see Page 47). If a wrong character is entered, use the [EC] key to "backspace" and delete that character and then continue. Remember, the [DEPT] key accesses the letters in the lower green section of the Department keys.
6. PRESS the [CHECK/STUBS] key to finalize.

TO PROGRAM DEPARTMENTS AS NON-TAXABLE

Although the factory default setting of all departments is non-taxable, you may need to program certain department keys for the non-tax setting.

<p>"PRG" + (Standard/Food Stamp Dept.) + (Standard/Hash Dept.) + (Standard/Gallonage Dept.) + 1 digit # 1 digit # 1 digit # [Standard/Negative Dept.] + (Multiple/Single Entry) + (Group #) + (HDLO #) + (Tax Status #) + 1 digit # 1 digit # 1 digit # 1 digit # 2 digit # [SUBTOTAL W/TAX] + (Pre-set Price or "0") + [DEPARTMENT NUMBER] + (Description) + [CHECK/STUBS] 8 digit # 16 characters(maximum)</p>
--

Example: Program Department 2 as non-taxable, HDLO of "0", and Multiple Entry and preset price of \$1.00:

1. Turn the key to the "PRG" (PROGRAM) position.
2. If a PRG/Z Manager Password has been programmed, TYPE the (PASSWORD #), then PRESS the [CLERK] key, or if you did not program a PRG/Z Manager Password, go to Step 3.
3. ENTER (0), PRESS the [SUBTOTAL W/TAX] key.
4. ENTER (100), then PRESS the [DEPARTMENT 2] key. If you do not wish to preset a price, you must enter "0", then PRESS [DEPARTMENT 2]. You only need to continue with Steps 5 and 6 if you wish to program a department description. If not, you can stop after completing Step 4 by pressing the [CHECK/STUBS] key.

(Department Programming continues on the next page)

DEPARTMENT PROGRAMMING (Continued)

- To program a description, begin inputting characters using the alpha keyboard (Department Keys) or the Alphanumeric Code Chart if needed (see Page 47). If a wrong character is entered, use the **[EC]** key to delete that character and then continue. Remember, the **[DEPT]** key accesses the letters in the lower green section of the Department keys.
- PRESS** the **[CHECK/STUBS]** key to finalize.

DEPARTMENT PROGRAMMING FOR Department 21 to Department 99

"PRG" + (Standard/Food Stamp Dept.) + (Standard/Hash Dept.) + (Standard/Gallonage Dept.) + 1 digit # 1 digit # 1 digit #
(Standard/Negative Dept.) + (Multiple/Single Entry) + (Group #) + (HDLO #) + (Tax Status #) + 1 digit # 1 digit # 1 digit # 1 digit # 2 digit #
[SUBTOTAL W/TAX] + (Pre-set Price or "0") + [PLU/DEPT ALT] + (Department No.) + [DEPT] + 8 digit # 2 digit #
(Description) + [CHECK/STUBS] 16 characters (maximum)

COUPON DISCOUNT (CPN) (Continued)

<u>Tax Status Number</u>	<u>Conditions</u>
05 = Taxable by TAX 1 and TAX 3	Used to charge TAX 1 and TAX 3 rates on the discounted amount of an item (the amount after the coupon is deducted).
06 = Taxable by TAX 2 and TAX 3	Used to charge TAX 2 and TAX 3 rates on the discounted amount of an item (the amount after the coupon is deducted).
07 = Taxable by TAX 1, TAX 2 and TAX 3	Used to charge TAX 1, TAX 2 and TAX 3 rates on the and discounted amount of an item (the amount after the coupon is deducted).
08 = Taxable by TAX 4	Used to charge TAX 4 rate on the discounted amount of an item (the amount after the coupon is deducted).
09 = Taxable by TAX 1 and TAX 4	Used to charge TAX 1 and TAX 4 rates on the discounted amount of an item (the amount after the coupon is deducted).
10 = Taxable by TAX 2 and TAX 4	Used to charge TAX 2 and TAX 4 rates on the discounted amount of an item (the amount after the coupon is deducted).
11 = Taxable by TAX 1, TAX 2 and TAX 4	Used to charge TAX 1, TAX 2 and TAX 4 rates on the and discounted amount of an item (the amount after the coupon is deducted).
12 = Taxable by TAX 3 and TAX 4	Used to charge TAX 3 and TAX 4 rates on the discounted amount of an item (the amount after the coupon is deducted).
13 = Taxable by TAX 1, TAX 3 and TAX 4	Used to charge TAX 1, TAX 3 and TAX 4 rates on the and discounted amount of an item (the amount after the coupon is deducted).
14 = Taxable by TAX 2, TAX 3 and TAX 4	Used to charge TAX 2, TAX 3 and TAX 4 rates on the and discounted amount of an item (the amount after the coupon is deducted).
15 = Taxable by TAX 1, TAX 2, TAX 3 and TAX 4	Used to charge TAX 1, TAX 2, TAX 3 and TAX 4 rates on the discounted amount of an item (the amount after the coupon is deducted).

(The Coupon Discount programming continues on the next page)

PRICE LOOK-UP (PLU)

A total of 1600 Price Look Up codes (PLUs) are available on this cash register. Each PLU can be programmed with a 16 character description that will print on the tape. The Price-Look Up system allows for fast, accurate entry of an item and automatically records the number of items sold.

The first step in programming PLUs is to assign a PLU number between 1 and 1600 to each sales item. Second, the PLU Numbers must then be linked to a Department key which has the appropriate Tax Status needed for that PLU. For example, if PLU #1 is required to charge tax, then link it to a Department key which is set up for tax. Whereas, if PLU #2 is not required to charge tax, then link it to a Department key which is programmed for no tax. Lastly, each PLU (1-1600) can be programmed with a name or description. The PLU name will print on the receipt or journal tape as well as on the PLU report.

TO PROGRAM PLU's

"PRG"+ (PLU #) + [PLU] + (Bar Code) + [RA] + (Price) + [PLU/DEPT ALT] + (Link Dept #) +			
1-1600	14 digits (maximum)	8 digits	1 – 99
[DEPT] + (Name) + [CHECK/STUBS] + [# /ST/NS]			
16 Characters			

Example: Set PLU #1 with a \$2.99 price, linked to Department 1; description of "Apple":

1. Turn the key to the "PRG" (PROGRAM) position.
2. If a Manager Password has been programmed, ENTER the (PASSWORD #), then PRESS the [CLERK] key, or if you did not program a Manager Password, go to Step 3.
3. ENTER (1), then PRESS the [PLU] key.
4. If the Barcode Reader is used for registration, but if the Barcode Reader is not at hand for programming, ENTER the (Barcode No.) and PRESS the [RA] key. Direct entry with the Barcode Reader is also available. Just scan the code. If you do not use a barcode reader for registration, in other words, if you use PLU number (from 1 to 1600) only, the steps of (barcode) and [RA] can be skipped.
5. ENTER (299), then PRESS the [PLU/DEPT ALT] key.
6. ENTER (1), then PRESS the [DEPT] key (Link Dept No.).
7. Input the characters (A)(P)(P)(L)(E) using the alpha keyboard [Department keys] or the Alphanumeric Code Chart, if needed (see Page 47). Remember the Department Shift key accesses the letters in the lower green section on the Department keys.
8. PRESS the [CHECK/STUBS] key.
9. Repeat Steps 3, 4, 5, 6, 7 and 8 to program other PLUs.
10. PRESS the [# /ST/NS] key to end programming of PLUs.

NOTE: Instead of above 5 and 6, the following step is available if the linked department number is 20 or less.
ENTER (299), then PRESS the [DEPARTMENT NUMBER] key.

Confirmation Report: To check your results, a PLU Confirmation Report is available. For details see Page 69.

TO SEARCH A VACANT PLU NUMBER

"PRG" + (0) + [PLU]

To program a new PLU, it is possible to make a PLU number displayed that the description is not yet programmed for.

Example: PLU 1 through PLU 100 are programmed already. To search a vacant PLU number:

1. Turn the key to the "PRG" (PROGRAM) position.
2. If a PRG Manager Password has been programmed, TYPE the (PASSWORD #) then PRESS the [CLERK] key, or if you did not program a PRG Manager Password, go to Step 3.
3. ENTER (0), then PRESS [PLU]
4. "PLU 101" is displayed.
5. Continuously, PLU 101 can be programmed.

TO DELETE PLU DATA

"PRG" + (PLU #) + [PLU] + [PLU/DEPT ALT] + (0) + [DEPT] + [#ST/NS]
1-1600

To delete the data of designated PLU number (in 1 – 1600) that has been programmed.

Example: PLU 50 is already programmed. To delete the data of it:

1. Turn the key to the "PRG" (PROGRAM) position.
2. If a PRG Manager Password has been programmed, TYPE the (PASSWORD #) then PRESS the [CLERK] key, or if you did not program a PRG Manager Password, go to Step 3.
3. ENTER (50), then PRESS the [PLU] key and the [PLU/DEPT ALT] key in turn.
4. ENTER (0), then PRESS the [DEPT] key.
5. PRESS the [#ST/NS] key to finalize.

TRAINING MODE

The optional Training Mode is designed to help you become better acquainted with the register mode and offers an ideal place for "beginners" and new employees to practice transaction examples. Once the Training Mode is activated, there is no access to any operations in the "PRG", "X", or "Z" modes. Also note, the transaction numbers do not count up in the Register Mode until you exit the Training Mode. The Training Mode can be activated at any time since it does not record any activity in the machine totals.

TO TURN ON THE TRAINING MODE

"PRG" + (666666) + [AMOUNT TEND/TOTAL]

1. Turn the key to the "PRG" (PROGRAM) position.
2. If a PRG/Z manager password has been programmed, **TYPE** the (PASSWORD #), then **PRESS** the [CLERK] key, or if you did not program a PRG/Z manager password, go to Step 3.
3. **ENTER (666666)**, then **PRESS** the [AMOUNT TEND/TOTAL] key.
4. Turn the key to the "REG" (REGISTER) position to resume normal register operations.

NOTE: The Training Mode indicator light (a small decimal point) will be displayed in the first digit of the display.

TO SHUT OFF THE TRAINING MODE

"PRG" + (555555) + [AMOUNT TEND/TOTAL]

1. Turn the key to the "PRG" (PROGRAM) position.
2. If a PRG/Z manager password has been programmed, **TYPE** the (PASSWORD #), then **PRESS** the [CLERK] key, or if you did not program a PRG/Z manager password, go to Step 3.
3. **ENTER (555555)**, then **PRESS** the [AMOUNT TEND/TOTAL] key.
4. Turn the key to the position desired.

GRAND TOTAL PRESET

The Grand Total is located at the bottom of your "Z" Report. The Grand Total is the only figure that does not reset back to zero after taking a "Z" Report. It is commonly known as the "running grand total". However, if you wish, you can reset the Grand Total to zero or assign it a specific value. The procedure used to assign a value to the Grand Total may be helpful after a Full System Clear is performed; since it automatically resets the Grand Total back to zero.

TO SET THE GRAND TOTAL TO ZERO

The Grand Total can be a maximum of 12 digits. When clearing the Grand Total, it is recommended to follow these steps to reset the total to zero.

"PRG" + (777777) + [AMOUNT TEND/TOTAL] + (0) + [NON TAX]

NOTE: It is recommended to take a "Z" reading prior to setting the Grand Total to zero.

1. Turn the key to the "PRG" (PROGRAM) position.
2. If a Manager Password has been programmed, ENTER the (PASSWORD #), then PRESS the [CLERK] key, or if you did not program a Manager Password, go to Step 3.
3. ENTER (777777), PRESS the [AMOUNT TEND/TOTAL] key, ENTER (0), then PRESS the [NON TAX] key.

TO ASSIGN A VALUE TO THE GRAND TOTAL

"PRG" + (777777) + [AMOUNT TEND/TOTAL] + (Assigned Value) + [NON TAX]
12 digits (maximum)

Example: Set the Grand Total for \$15,000.00:

1. Turn the key to the "PRG" (PROGRAM) position.
2. If a Manager Password has been programmed, ENTER the (PASSWORD #), then PRESS the [CLERK] key, or if you did not program a Manager Password, go to Step 3.
3. ENTER (777777) then PRESS the [AMOUNT TEND/TOTAL] key.
4. ENTER (1500000) then PRESS the [NON TAX] key.

TRANSACTION NUMBER PRESET

Transaction Number Preset allows you to choose a beginning transaction number of your own. The Transaction Number normally begins with the number 0001 and counts up consecutively until a "Z" Report is taken; thereafter it resets back to 0001. Transaction Number Preset can also be used to re-enter the last transaction number in the event information is lost.

Extra Option: The register is programmed not to have the Transaction Number reset to zero after a "Z" Report is taken. If desired, a procedure is offered to have the Transaction Number reset to zero after a "Z" Report is taken. See Flag 15, on Page 60.

TO PROGRAM THE TRANSACTION NUMBER

"PRG" + (1) + (TRANSACTION #) + [PO] 4 digit # (in range 0000 -9999)

Example: To program the Transaction Number to be 1000:

1. Turn the key to the "PRG" (PROGRAM) position.
2. If a Manager Password has been programmed, ENTER the (PASSWORD #), then PRESS the [CLERK] key, or if you did not program a Manager Password, go to Step 3.
3. ENTER (1), (1000), then PRESS the [PO] key.

ROUNDING METHOD for FINALIZING AMOUNT

Your cash register allows you to select the method used for rounding when a sales transaction is finished. There are five methods for rounding: rounding up, rounding (If the 0.00 is displayed and printed, 0.01 to 0.04 becomes 0.00, 0.05 to 0.09 becomes 0.10). round down, the Swiss method and the Danish method. For information about the Swiss and Danish methods, consult your dealer. Select the rounding method as follows:

TO PROGRAM THE ROUNDING FOR FINALIZING AMOUNT

"PRG" + (3) + (N1 N2) + (N3 N4) + [PO]
 Method: Rounding position:
 Select from the Select from the
 following table : following table:

	<u>No.</u>	<u>Condition</u>
N 1 N 2	0 0	Select rounding up.
	0 4	Select rounding.
	0 9	Select rounding down.
	0 2	Select the Swiss method of rounding.
	1 2	Select the Danish method of rounding.
N 3 N 4	0 0	Does not round.
	1 0	Round the last digit.
	0 5	Round the position according to the Swiss method of rounding.
	2 5	Round the position according to the Danish method of rounding.

Example: N 1 N 2 : 0 4 (Select rounding.)
 N 3 N 4 : 1 0 (Round the last digit.)

1. Turn the key to the "PRG" (PROGRAM) position.
2. If a Manager Password has been programmed, ENTER the (PASSWORD #), then PRESS the [CLERK] key, or if you did not program a Manager Password, go to Step 3.
3. ENTER (3), (0 4), (1 0), then PRESS the [PO] key.

X1 and X2 COUNTER PRESET

X1 and X2 COUNTER PRESET

- X1: Represents the End-of-Day reading (resets totals to "0").
- X2: Represents the End-of-Week/Month reading (resets totals to "0").

Allows you to select the beginning number for the X1 Counter. The "X" Counter is programmed by the factory to count up consecutively after each "X" reading. It provides a tally of the number of "X" readings from the first "X" reading taken on the cash register to the present. In the event a Full System Clear procedure is performed (which resets all data to zero), the "X" Counter Preset feature will also allow you to re-enter the previous "X" Counter Number.

TO PROGRAM THE X1 COUNTER NUMBER

"PRG" + (3) + (X1 COUNTER #) + [RETURN]
4 digit #

Example: To program the X1 Counter for the number 0098:

1. Turn the key to the **"PRG" (PROGRAM) position.**
2. If a Manager Password has been programmed, **ENTER** the **(PASSWORD #)**, then **PRESS** the **[CLERK]** key, or if you did not program a Manager Password, go to Step 3.
3. **ENTER (3), (0098)**, then **PRESS** the **[RETURN]** key.

TO PROGRAM THE X2 COUNTER NUMBER

"PRG" + (4) + (X2 COUNTER #) + [RETURN]
4 digit #

Example: To program the X2 Counter for the number 0099:

1. Turn the key to the **"PRG" (PROGRAM) position.**
2. If a Manager Password has been programmed, **ENTER** the **(PASSWORD #)**, then **PRESS** the **[CLERK]** key, or if you did not program a Manager Password, go to Step 3.
3. **ENTER (4), (0099)**, then **PRESS** the **[RETURN]** key.

Z1 and Z2 COUNTER PRESET

- Z1: Represents the End-of-Day reading (resets totals to "0").
Z2: Represents the End-of-Week/Month reading (resets totals to "0").

Allows you to select the beginning number for the Z1 Counter. The "Z" Counter is programmed by the factory to count up consecutively after each "Z" reading. It provides a tally of the number of "Z" readings from the first "Z" reading taken on the cash register to the present. In the event a Full System Clear procedure is performed (which resets all data to zero), the "Z" Counter Preset feature will also allow you to re-enter the previous "Z" Counter Number.

TO PROGRAM THE Z1 COUNTER NUMBER

"PRG" + (1) + (Z1 COUNTER #) + [RETURN] 4 digit #
--

Example: To program the Z1 Counter for the number 0050:

1. Turn the key to the **"PRG" (PROGRAM) position**.
2. If a Manager Password has been programmed, **ENTER** the **(PASSWORD #)**, then **PRESS** the **[CLERK]** key, or if you did not program a Manager Password, go to Step 3.
3. **ENTER (1), (0050)**, then **PRESS** the **[RETURN]** key.

TO PROGRAM THE Z2 COUNTER NUMBER

"PRG" + (2) + (Z2 COUNTER #) + [RETURN] 4 digit #
--

Example: To program the Z2 Counter for the number 0100:

1. Turn the key to the **"PRG" (PROGRAM) position**.
2. If a Manager Password has been programmed, **ENTER** the **(PASSWORD #)**, then **PRESS** the **[CLERK]** key, or if you did not program a Manager Password, go to Step 3.
3. **ENTER (2), (0100)**, then **PRESS** the **[RETURN]** key.

PROGRAMMING ALPHANUMERIC DESCRIPTIONS

General Information: When programming the alpha descriptions for Departments, PLUs, Clerks and the Store Name/Logo Message and Commercial Messages, it is recommended to use the Alpha keyboard (shown below). The department keys are clearly labeled with all the letters needed to program these descriptions. So, when you are programming alpha descriptions, simply use the department keys to spell out the words you require. Please note that the letters in the lower green section of the keys are accessed by first pressing the [DEPT] key. You may require certain symbols or lower case characters that are not found on the Alpha Keyboard. For example, if you require a space between words, or if you require the "/" symbol, or "-", you will need to refer to the Alphanumeric Code Chart shown on the next page.

The [EC] key functions as a back space and delete key when programming alpha characters.

PLEASE NOTE: Only capital letters of the alphabet are on the Alpha Keyboard.

ALPHA KEYBOARD

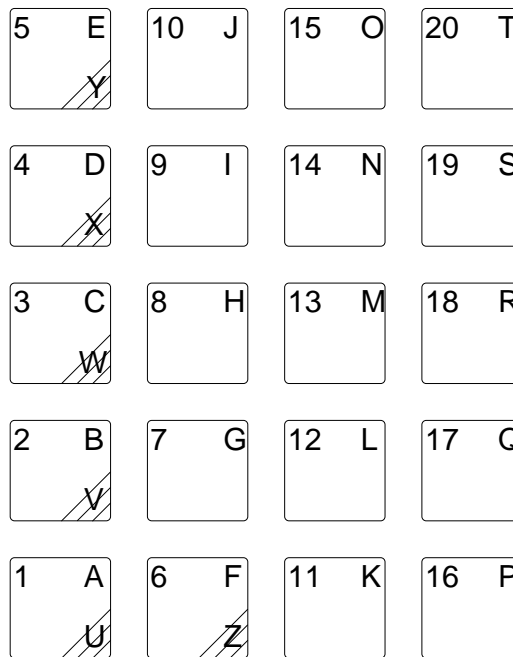

TO INPUT CHARACTERS

Example: SPORTSWEAR (10 characters)

*To input the letter of "W", PRESS the [DEPT] key to shift and the [Department 3 (=W)] key.

*The following operation example includes a typing mistake. To correct it, press the [EC] key to delete the mistaken character.

<u>Operation</u>	<u>Display</u>
1 Type (SPOR)	SPOR
2 Type (J) (by mistake)	SPORJ
3 Press the [EC] key to delete the letter "J"	SPOR
4 Type (TS)	SPORTS
5 Press the [DEPT] key, then type "W"	SPORTSW
6 Type (EAR), then press the [CHECK/STUBS] key to finalize.	SPORTSWEAR

(Programming Alphanumeric Descriptions are continued on the next page)

(Continued) **PROGRAMMING ALPHANUMERIC DESCRIPTIONS**

ALPHANUMERIC CODE CHART

Character	Code Number	Character	Code Number	Character	Code Number
Space	00	@	40	/	67
Wide Character	01	A	41	:	68
a	02	B	42	#	69
b	03	C	43	&	70
c	04	D	44	%	71
d	05	E	45	\$	72
e	06	F	46	, (comma)	73
f	07	G	47	(74
g	08	H	48)	75
h	09	I	49	*	76
i	10	J	50	+	77
j	11	K	51	-	78
k	12	L	52	.	79
l	13	M	53	; (semi-	87
m	14	N	54	colon)	88
n	15	O	55	>	89
o	16	P	56	' (apostrophe)	90
p	17	Q	57	"	91
q	18	R	58	<	92
r	19	S	59	=	
s	20	T	60		
t	21	U	61	Special Language	
u	22	V	62	Characters	
v	23	W	63	i	80
w	24	X	64	ç	81
x	25	Y	65	á	82
y	26	Z	66	é	83
z	27			í	84
?	28			ó	85
!	29			ú	86
0	30			Ä	87
1	31			Û	88
2	32			Ö	89
3	33			Ï	90
4	34			ü	91
5	35			Ñ	92
6	36			ñ	93
7	37				
8	38				
9	39				

Locate the character or symbol that you need, and note the 2 digit code number. For example, if you require a space, the code number for a space is "00", the number 1 is the code 31 and the ":" (colon) is code 68.

(Programming Alphanumeric Descriptions are continued on the next page)

PROGRAMMING ALPHANUMERIC DESCRIPTIONS (Continued)

The following outlines the maximum number of characters that can be programmed for each item description.

DEPARTMENT	-	16 Characters *
PLU	-	16 Characters *
CLERK NAME	-	24 Characters *
STORE LOGO/HEADER	-	9 Lines (24 Characters* each)
COMMERCIAL MESSAGE	-	9 Lines (24 Characters* each)

* Standard size characters. For Double Width, see below.

Please Note: The instructions for programming Department Descriptions is on Pages 28-32.
 The instructions for programming PLU Descriptions is on Page 38-39.
 The instructions for programming Clerk Descriptions is on Pages 20-21.
 The instructions for programming Commercial Messages is on Pages 49-51.

WIDE CHARACTERS

For extra emphasis, you can program extra wide (double width) for each character.

If using double width characters, the maximum number of characters is reduced by half. For example, Departments would normally use 16 characters, for double width, the maximum is 8 characters; PLUs would normally use 16 characters, for double width, the maximum is 8 characters.

To make a character print extra wide, the double width code of "01" must be used before each character.

Normal Size

```

*****
      YOUR RECEIPT
      Thank You
      Call again
*****
APPLE 1           1.00
MILK 1           2.00
ITEM CT  2
TAX                0.06%
CASH 3.06
03-24-2002      PM 04:14
                0006
CLERK01
    
```

Double Width

```

*****
      YOUR RECEIPT
      Thank You
      Call again
*****
APPLE 1           1.00
MILK 1           2.00
ITEM CT  2
TAX                0.06%
CASH 3.06
03-24-2002      PM 04:14
                0006
CLERK01
    
```

PROGRAMMING ALPHANUMERIC DESCRIPTIONS (Continued)

Step 3: Next, fill in the chart, filling in extra unused characters with blank spaces. Note that blank spaces were added at the beginning and end of each line in order to **CENTER** the logo.

1st line	00	00	I	N	T	E	R	N	A	T	I	O	N	A	L	00	C	O	F	F	E	E	S	00
2nd line	00	01	39	01	39	01	39	78	01	35	01	35	01	35	78	01	31	01	31	01	31	01	31	00
3rd line	00	00	32	32	32	00	E	A	S	T	00	M	A	I	N	00	S	T	R	E	E	T	00	00
4th line	00	00	00	00	O	P	E	N	00	37	A	M	00	T	O	00	36	P	M	00	00	00	00	00
5th line	00	00	C	O	F	F	E	E	S	00	O	F	00	T	H	00	W	O	R	L	D	00	00	
6th line																								
7th line																								
8th line																								
9th line																								

NOTE: Re: Programming Numbers in Logo Message:

1. If you require the printing of numbers, for example, for a telephone number or part of the street address, the numbers must be entered using the Alphanumeric Code Chart on Page 47. For example, for the telephone number "999-555-1111" in the above example, the number 9 was programmed using the character code "39"; the number 5 was programmed using the code "35", etc.
2. Note that the phone number was programmed using double width characters (code "01" before each number for double width)

PRINTED RESULT: Example of programmed Store Logo:

INTERNATIONAL COFFEES
999-555-1111
222 EAST MAIN STREET
OPEN 7AM TO 6PM
COFFEES OF THE WORLD

Step 4: Program your logo

1. Turn the key to the "PRG" (PROGRAM) position.
2. If a PRG/Z Manager Password has been programmed, TYPE the (PASSWORD #), then PRESS the [CLERK] key, or if you did not program a PRG/Z Manager Password, go to Step 3.
3. 1st Line: TYPE (71), PRESS the [RETURN] key (Logo line 1 appears on the display), enter the 1st line of the logo (up to 24 characters) and then PRESS the [CHECK/STUBS] key.
 2nd Line: TYPE (72), PRESS the [RETURN] key (Logo line 2 appears on the display), enter the 2nd line of the logo (up to 24 characters) and then PRESS the [CHECK/STUBS] key.
 3rd Line: TYPE (73), PRESS the [RETURN] key (Logo line 3 appears on the display), enter the 3rd line of the logo (up to 24 characters) and then PRESS the [CHECK/STUBS] key.
 4th Line: TYPE (74), PRESS the [RETURN] key (Logo line 4 appears on the display), enter the 4th line of the logo (up to 24 characters) and then PRESS the [CHECK/STUBS] key.
 5th Line: TYPE (75), PRESS the [RETURN] key (Logo line 5 appears on the display), enter the 5th line of the logo (up to 24 characters) and then PRESS the [CHECK/STUBS] key.

Step 5: Enter (705), then PRESS the [RETURN] key, (5 Line is selected), (Max 9 line can be programmed).

* Remember, when entering any alpha descriptions, if a wrong character is entered, use the [EC] key to "backspace" and delete that character and then continue.

SCROLL MESSAGES

The following outlines the types of scrolling messages that can be programmed:

1. OFF message – Message that runs in the OFF position
2. MODE message – Message that runs during the idle state in PRG, X, Z modes
3. SALES message – Message that runs after the sales transaction
4. IDLE message 1 – Message that runs during the idle state in REG modes *
5. IDLE message 2 – Message that runs during the idle state in REG modes *

* IDLE messages 1 and 2 can be combined for 1 longer message.

Each scroll message can be programmed for a maximum of 42 characters. Messages 4 and 5 (IDLE messages) can be combined for a maximum of 84 characters.

TO PROGRAM A MESSAGE:

1. Turn the key to the "PRG" (PROGRAM) position.
2. If a PRG/Z Manager Password has been programmed, TYPE the (PASSWORD #), then PRESS the [CLERK] key, or if you did not program a PRG/Z Manager Password, go to Step 3.
3. ENTER (6), PRESS (the message number), PRESS the [RETURN] key, begin inputting characters using the alpha keyboard (Department keys) or the Alphanumeric Code Chart, if needed, (see Page 47). If a wrong character is entered, use the [EC] key to "backspace" and delete that character and then continue. Remember, the [DEPT] key accesses the letters in the lower green section of the Department keys.
4. PRESS the [CHECK/STUBS] key to finalize.

"PRG" + (6n) + [RETURN] + (xxx...xxx) + [CHECK/STUBS]
(42 characters max)

EXAMPLE: To program the OFF (SCROLL MESSAGE #1) message:

"PRG" + (6) + (1) + [RETURN] + (Message) + [CHECK/STUBS]
(42 characters max)

EXAMPLE: To program the MODE (SCROLL MESSAGE #2) message:

"PRG" + (6) + (2) + [RETURN] + (Message) + [CHECK/STUBS]
(42 characters max)

EXAMPLE: To program the SALES (SCROLL MESSAGE #3) message:

"PRG" + (6) + (3) + [RETURN] + (Message) + [CHECK/STUBS]
(42 characters max)

EXAMPLE: To program the IDLE (SCROLL MESSAGE #4 or 5) message:

"PRG" + (6) + (4 or 5) + [RETURN] + (Message) + [CHECK/STUBS]
(42 characters max)

SCROLL MESSAGE SETTINGS

- 1- **OFF message: SCROLL MESSAGE #1 DISPLAY TIME (Number of seconds after the register is turned off before the message starts)**
Note: Pressing the [FEED] key after the message starts will stop the OFF message from displaying.
Settings: 01 – 99 (Default=05), 00: No message will scroll.

“PRG” + (1) + (# of Seconds) + [CHARGE]
2 digit # 01-99

- 2- **MODE message: SCROLL MESSAGE #2 DISPLAY TIME (Number of seconds before the register turns into idle mode in PRG, X , Z modes and the message starts.)**
This message will not display in REG modes.
Settings: 01 – 99 (Default=05) , 00: No message will scroll.

“PRG” + (2) + (# of Seconds) + [CHARGE]
2 digit # 01-99

- 3- **SALES message: SCROLL MESSAGE #3 DISPLAY TIME (Number of seconds after a sale completion in REG mode before message starts).** When a transaction is begun the SALES message will stop. It will resume after the sale is completed and the number of seconds programmed has elapsed.
Settings: 01 – 99 (Default=10), 00: No message will scroll.

“PRG” + (3) + (# of Seconds) + [CHARGE]
2 digit # 01-99

- 4- **SALES message: SCROLL MESSAGE #4 DISPLAY TIME (Number of seconds for Sales message to run before the Idle message starts.)**
Settings: 01 – 99 (Default=20) 00 = No message will scroll.

“PRG” + (4) + (# of Seconds) + [CHARGE]
2 digit # 01-99

- 50- **Idle message 1: TIME DISPLAY (Number of seconds for clock display after Sales message.)**
When the Time changes while an Idle message is running, the Time is shown first for a few seconds, then restarts with the idle message.
Settings: 1 – 9 (Default=2) 0 = No message will scroll.

“PRG” + (50) + (# of Seconds) + [CHARGE]
1 digit # 1-9

- 60- **Idle message 2: SCROLL FLAG(Selection of idle message patterns.)** Setting to 0 will run Idle message 1 in the AM and Idle message 2 in the PM. Setting to 1 will combine the two Idle messages and run both in AM and PM.
Settings: 0 – 1 (Default=0)

“PRG” + (60) + (0 or 1) + [CHARGE]

- 70- **Amount of time for each letter of a message to appear on the display: SCROLL SPEED**

“PRG” + (70) + (#) + [CHARGE]
1 digit # 0-7

- 70# 0 = Fastest 2 = (Default) 7 = Slowest
Any integer between 0 and 7 can be chosen.

SCROLL MESSAGE PATTERNS

- SALES COMPLETION
 - TOTAL IS ON DISPLAY
 - SALES MESSAGE STARTS
 - SALES MESSAGE RUNS
 - IDLE MESSAGE 1-2
- DISPLAY

CA 1.00

PLEASE TAKE YOUR RECEIPT

PLEASE TAKE YOUR RECEIPT

STORE HOURS 9 AM TO 10PM SPECIAL SALE ON WEDNESDAY

* IDLE MESSAGE 1 RUNS IN THE AM AND 2 RUNS IN THE PM. IF 1 AND 2 ARE COMBINED, BOTH WILL RUN IN AM AND PM.

DURING THE IDLE MESSAGE WHEN THE TIME CHANGES EACH MINUTE THE TIME WILL BE DISPLAYED AND THEN RETURN TO THE IDLE MESSAGE.

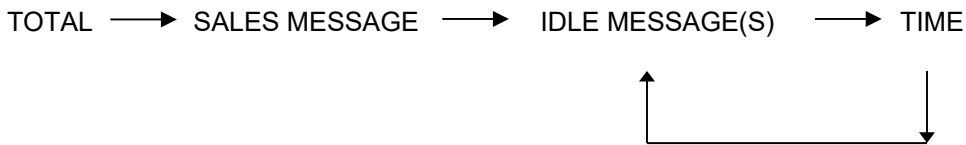

DEFAULT SCROLL MESSAGES

- | | |
|---------------|---------------------------------|
| [OFF MES.] | 1: CLOSED, NEXT REGISTER PLEASE |
| [MODE MES.] | 2: PLEASE WAIT |
| [SALES MES.] | 3: PLEASE TAKE YOUR RECEIPT |
| [IDLE-1 MES.] | 4: GOOD MORNING |
| [IDLE-2 MES.] | 5: GOOD AFTERNOON |

SOME EXAMPLES OF MESSAGES THAT CAN BE PROGRAMMED TO SCROLL:

- ASK ABOUT OUR DAILY SPECIALS
- WE DELIVER
- 10% DISCOUNT ON THURSDAY
- FREE SODA WITH ANY SANDWICH ORDER
- STORE HOURS 9AM TO 10PM

Remember, by combining messages 4 and 5 a message of up to 84 characters can be programmed.

NOTE: To verify your scrolling messages and settings you may print a Program Confirmation report as shown on Page 66.

TO PROGRAM THE TRANSACTION WORDS

Transaction words are linked to the function keys and they are printed on receipts and reports.

The length of transaction word is limited up to eight regular size characters or four double size characters. They can be changed to desired words very easily.

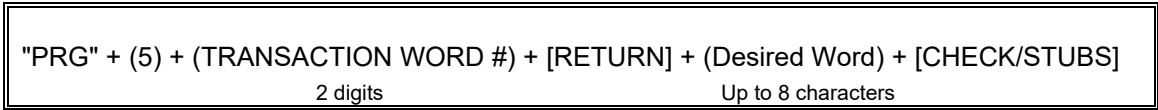

Example:

How to change the transaction word, "CHARGE" (Transaction Word #26) to "VISA"

1. Turn the key to the "PRG" (PROGRAM) position.
2. If a Manager Password has been programmed, ENTER the (PASSWORD #), then PRESS the [CLERK] key, or if you did not program a Manager Password, go to Step 3.
3. ENTER (5), (26), then PRESS [RETURN]
4. PRESS [DEPT], then enter (V, I, S, A) and PRESS the [CHECK/STUBS] key.

Note: Pressing the [DEPT] key in Step 4 is needed for entering the letter "V".

Transaction Words (English):

<u>No.</u>	<u>Transaction Word</u>	<u>Function</u>
01	DEPT TTL	Department Total
02	NOTXBL	Non-taxable
03	TXBL-1	Taxable 1
04	TXBL-2	Taxable 2
05	TXBL-3	Taxable 3
06	TXBL-4	Taxable 4
07	TAX-1	Tax 1 Amount
08	TAX-2	Tax 2 Amount
09	TAX-3	Tax 3 Amount
10	TAX-4	Tax 4 Amount
11		(Not used. Do not change)
12	+%G	+% Gross
13	+%N	+% Net
14	TOTAL	Total
15	GROSS	Gross

TO PROGRAM THE TRANSACTION WORDS (Continued)

<u>No.</u>	<u>Transaction Word</u>	<u>Function</u>
16	VOID-R	Void on Department & PLU
17	RETURN	Return
18	COUPON G	Coupon Gross
19	COUPON N	Coupon Net
20	-%G	-% Gross
21	-%N	-% Net
22	ROUND	Rounding
23	NET TL	Net Total
24	CASH	Cash Total
25	CHECK	Check Total
26	CHARGE	Charge Total
27	CHARGE2	Charge 2 Total
28	CHARGE3	Charge 3 Total
29		(Not used. Do not change)
30		(Not used. Do not change)
31	NOSALE	Non-sale
32	R/A CA	Received on Account, Cash
33	R/A CK	Received on Account, Check
34	P/O CA	Paid Out, Cash
35	P/O CK	Paid Out, Check
36	CAID	Cash in Drawer
37	CKID	Check in Drawer
38	NRGT	Non-resettable Grand Total
39	TAX	Tax
40	NET*	(Not used. Do not change)
41	MSC-V	Void on Minus Item
42	MSC-R	Return on Minus Item

(Continued) **TO PROGRAM THE TRANSACTION WORDS**

<u>No.</u>	<u>Transaction Word</u>	<u>Function</u>
43		(Not used. Do not change)
44		(Not used. Do not change)
45	CASH TD	Cash Tendered
46	CHECK TD	Check Tendered
47	VOID	Void
48	TAXTOTAL	Tax Total
49	NET-TAX	Net Amount - Tax
50	DEPT GRP	Department Group
51	RPRT CNT	Report Counter
52	SUB-TTL	Sub-total
53	CHANGE	Change
54	-VOID-	Void
55	RETURN	Return
56	ITEM CT	Item Count
57	NET	Net Sales
58	R/A	Received on Account
59	P/O	Paid Out
60		(Not used. Do not change)
61		(Not used. Do not change)
62		(Not used. Do not change)
63		(Not used. Do not change)
64		(Not used. Do not change)
65		(Not used. Do not change)
66		(Not used. Do not change)
67		(Not used. Do not change)
68		(Not used. Do not change)
69		(Not used. Do not change)

TO PROGRAM THE TRANSACTION WORDS (Continued)

<u>No.</u>	<u>Transaction Word</u>	<u>Function</u>
70		(Not used. Do not change)
71		(Not used. Do not change)
72		(Not used. Do not change)
73		(Not used. Do not change)
74		(Not used. Do not change)
75		(Not used. Do not change)
76		(Not used. Do not change)
77		(Not used. Do not change)
78		(Not used. Do not change)
79		(Not used. Do not change)
80	FS SALES	Food Stamp Sales
81	FS TEND	Food Stamp Tendered
82	FS CHNG	Food Stamp Change
83	FS TOTAL	Food Stamp Total
84	FS IN DW	Food Stamp in Drawer
85	HASH TTL	Hash Total

FLAG OPTIONS

A total of 90 system programming options (known as FLAGS) are offered on this cash register. They are preset at the factory to accommodate the most commonly used selections. Each flag option can be changed or updated at any time as needed.

NOTE: Most flags have been factory preset at "0". They only need to be programmed if you wish to change any option from "0" to "1".

"PRG" + (FLAG #) + (Selected option #) + [VOID]

The options are as follows: "0" = Represents the option present by the factory.

"1" = Represents an alternative option.

FLAG NUMBER	OPTION NUMBER
FLAG OPTION	
1	0 = Year, month, date, in that order. 1 = Month, date, year, in that order. 2 = Date, month, year, in that order.
2	0 = Display and print the time in 12 hour (AM/PM) format. 1 = Display and print the time in 24 hour format.
3	0 = 0 Decimal position for monetary system. 1 = 0.0 Decimal position for monetary system. 2 = 0.00 Decimal position for monetary system. 3 = 0.000 Decimal position for monetary system.
4	METHOD FOR MULTIPLICATION & % CALCULATIONS 0 = Rounding down (0.1 to 0.9 becomes 0.0) 5 = Rounding (0.1 to 0.4 becomes 0.0, 0.5 to 0.9 becomes 1.0) 9 = Rounding up (0.1 to 0.9 becomes 1.0)
5	ROUNDING METHOD FOR TAX CALCULATIONS 0 = Rounding down (0.1 to 0.9 becomes 0.0) 5 = Rounding (0.1 to 0.4 becomes 0.0 and 0.5 to 0.9 becomes 1.0) 9 = Rounding up (0.1 to 0.9 becomes 1.0)
6	ROUNDING POSITION FOR MULTIPLICATION & % CALCULATIONS 0 = Select the first digit in the decimal to be rounded in percentage and multiplication calculations. 1 = Select the last digit to be rounded in percentage multiplication calculations.
7	ROUNDING POSITION FOR TAX CALCULATIONS 0 = Select the first digit in the decimal to be rounded in tax calculations. 1 = Select the last digit in the decimal to be rounded in tax calculations.
8	0 = First enter the quantity, then enter the price. 1 = First enter the price, then enter the quantity.
9	0 = Do not automatically add the preset percentage for the [+ %] key to the sales amount. 1 = Automatically add the preset percentage for the [+ %] key to the sales amount.

FLAG OPTIONS (Continued)

FLAG NUMBER	DESCRIPTION
10	<p>0 = Print the department total sales amount as a net amount on the report: the total amount including calculations made with the [+ %] and [- %] keys.</p> <p>1 = Print the department total sales amount as a gross amount on the report: the total amount not including calculations made with the [+ %] and [- %] keys.</p>
11	<p>0 = Print the department total sales amount as a net amount on the report; the total amount including calculations made with the [- /CPN] key.</p> <p>1 = Print the department total sales amount as a gross amount on the report; the total amount not including calculations made with the [- /CPN] key.</p>
12	<p>0 = Print the number of transactions on the hourly report.</p> <p>1 = Print the number of items on the hourly report.</p>
13	<p>0 = Print a programmed commercial message on the header position on the receipt.</p> <p>1 = Print a programmed commercial message on the trailer position on the receipt.</p>
14	<p>0 = Print a programmed Date, time, Transaction # and Clerk Name at the end of the receipt.</p> <p>1 = Print a programmed Date, Time, Transaction # and Clerk Name on the header position of the receipt.</p>
15	<p>0 = Do not reset the transaction number (consecutive number) after issuing the "Z" report.</p> <p>1 = Reset the transaction number (consecutive number) after issuing the "Z" report.</p>
16	<p>0 = Clerk System inactive.</p> <p>1 = Clerk System active.</p>
17	<p>0 = Do not reset the Clerk Password each time the position of the control lock is changed.</p> <p>1 = Reset the Clerk Password each time the position of the control lock is changed.</p>
18	<p>0 = Do not reset the Clerk Password after each sales transaction is finished.</p> <p>1 = Reset the Clerk Password after each sales transaction is finished.</p>
19	<p>0 = Do not require a manager password when issuing an individual clerk report.</p> <p>1 = Require a manager password when issuing an individual clerk report.</p>
20	<p>0 = The Grand Total does not reset after a "Z" Reading.</p> <p>1 = The Grand Total resets after a "Z" Reading.</p>
21	<p>0 = Tax amount will print before the sales total on the sales receipt.</p> <p>1 = Tax amount will print after the sales total on the sales receipt.</p>
LINES FEED COUNT AFTER RECEIPT ISSUE	
22	<p>0 = 0 Line</p> <p>1 = 1 Line</p> <p>2 = 2 Line</p> <p>3 = 3 Line</p> <p>4 = 4 Line</p> <p>5 = 5 Line</p> <p>6 = 6 Line</p> <p>7 = 7 Line</p> <p>8 = 8 Line</p> <p>9 = 9 Line</p>

FLAG NUMBER	DESCRIPTION
23	0 = Print the time on the receipt / journal. 1 = Do not print the date on the journal at Registration mode.
24	0 = Print the date on the receipt / journal at Registration mode. 1 = Do not print the date on the receipt / journal at Registration mode.
25	0 = Print “,” (comma) as punctuation symbol. 1 = Print “.” (period) as punctuation symbol.
26	0 = Not used.
27	0 = Print receipt after Finalized. 1 = Print receipt after Registration.
28	0 = Print journal after Finalized. 1 = Print journal after Registration.
29	0 = Print the transaction number (consecutive number) on the receipt / journal. 1 = Do not print the transaction number (consecutive number) on the receipt / journal.
30	0 = Print the item count on the receipt / journal. 1 = Do not print the item count on the receipt / journal.
31	VAT TAXABLE PRINT 0 = Do not Print the Value Added Tax (VAT) on the receipt / journal. 1 = Print the Value Added Tax (VAT) on the receipt / journal.
32	VAT TAX PRINT 0 = Do not print the VAT separately for items which are taxable. 1 = Print the VAT separately for items which are taxable.
33	0 = Do not print taxable amount on the receipt. 1 = Print taxable amount on the receipt.
34	0 = Print the summary tax amount of tax 1, 2, 3, 4. 1 = Print the individual tax amount of tax 1, 2, 3, 4.
35	0 = Print tax symbol on receipt. 1 = Do not print tax symbol on receipt.
36	0 = Do not print tax rate on receipt. 1 = Print tax rate on receipt.
37	0 = Print voided amounts on the reports. 1 = Do not print voided amounts on the reports.
38	0 = Print the grand total amount on the reports. 1 = Do not print the grand total amount on the reports.
39	0 = Print the total sales for departments on the reports. 1 = Do not print the total sales for departments on the reports.
40	NON - TAXABLE TOTAL 0 = Print non-taxable total on reports. 1 = Do not print non-taxable total on reports.

FLAG OPTIONS (Continued)

FLAG NUMBER	DESCRIPTION
41	PRINT IN DRAWER 0 = Print cash amount and check in the drawer on the reports. 1 = Do not print cash amount and check in the drawer on the reports.
42	SKIP ZERO SALE TRANSACTION ON REPORTS 0 = Skip. 1 = Does not skip.
43	SKIP ZERO SALE PLUs ON REPORTS 0 = Skip amounts equaling zero on financial reports. 1 = Does not skip amounts equaling zero on financial reports.
44	X1 REPORT # 0 = X1 Counter will print. 1 = X1 Counter will not print.
45	X2 PERIODICAL REPORT # 0 = X2 Counter will print. 1 = X2 Counter will not print.
46	Z1 REPORT # 0 = Z1 Counter will print. 1 = Z1 Counter will not print.
47	Z2 PERIODICAL REPORT # 0 = Z2 Counter will print. 1 = Z2 Counter will not print.
48	PRINT PLU # 0 = Print PLU # 1 = Do not print PLU #
49	DOUBLE WIDE CHARACTER ON RECEIPT 0 = Print double size character of transaction name on receipt. 1 = Print normal size character of transaction name on receipt.
50	0 = Do not allow a duplicate "Z" report to print. 1 = Allow a duplicate "Z" report to print.
51	0 = Subtotal will print on sales receipts when [# / ST / NS] key is depressed. 1 = Subtotal will not print on sales receipts when [# / ST / NS] key is depressed.
52	0 = The Clerk Name will print on sales receipts. 1 = The Clerk Name will not print on sales receipts.
53	0 = Disable to change Clerk in transaction. 1 = Enable to change Clerk in transaction.
54	0 = Price zero entry causes an error. 1 = Price zero entry can be accepted.

(Continued) **FLAG OPTIONS**

FLAG NUMBER	DESCRIPTION
55	0 = Do not require the amount received from a customer and the calculation of the change. 1 = Require the amount received from a customer to be registered. 2 = Prohibit tendering.
56	0 = Enable registering transactions which more than one media is received, for example, cash and a check (split tendering). 1 = Disable registering transactions which more than one media is received, for example, cash and a check (split tendering).
57	0 = Enable pressing the [# /ST/NS] key immediately after entering numeric key. 1 = Disable pressing the [# /ST/NS] key immediately after entering numeric key.
58	0 = Enable pressing just the [# /ST/NS] key to open the cash drawer. 1 = Disable pressing just the [# /ST/NS] key to open the cash drawer.
59	0 = Enable the [VOID] [-/CPN] [RETURN][-%] keys used as minus departments in the "REG" mode. 1 = Disable the [VOID] [-/CPN] [RETURN][-%] keys used as minus departments in the "REG" mode.
60	0 = Enable using [RA] [PO] key in the "REG" (Register) position. 1 = Disable using [RA] [PO] key in the "REG" (Register) position.
61	0 = Cash declaration is not compulsory before a "Z1" reading. 1 = Cash declaration is compulsory before a "Z1" reading.
62	0 = Disable issuing a second complete receipt after issuing the first one. 1 = Enable issuing a second complete receipt by pressing the [SUBTOTAL W/TAX] key.
63	0 = Enable issuing a stub receipt (printed total only). 1 = Disable issuing a stub receipt.
64	0 = Open the drawer when you press the [AMOUNT TEND/TOTAL] key. 1 = Do not open the drawer when you press the [AMOUNT TEND/TOTAL] key.
65	0 = Open the drawer when you press the [CHECK/STUBS] key. 1 = Do not open the drawer when you press the [CHECK/STUBS] key.
66	0 = Open the drawer when you press the [CHARGE] key. 1 = Do not open the drawer when you press the [CHARGE] key.
67	0 = Open the drawer when you press the [CHARGE 2] key. 1 = Do not open the drawer when you press the [CHARGE 2] key.
68	0 = Open the drawer when you press the [CHARGE 3] key. 1 = Do not open the drawer when you press the [CHARGE 3] key.
69	0 = Make a key stroke sound. 1 = Do not make a key stroke sound.
70	0 = Enable reports for training. 1 = Disable reports for training.

FLAG OPTIONS (Continued)

FLAG NUMBER	DESCRIPTION
71	0 = Print on journal at Training Mode. 1 = Do not print on journal at Training Mode.
72	0 = Transaction Counter does not count up while in the Training Mode. 1 = Transaction Counter does count up while in the Training Mode.
S/O 1 (Speed 9600bps Fix) Chosen option numbers of Flag # 73 and # 77 must be different each other.	
73	S/O 1 Peripheral 0 = Barcode Scanner 1 = PC
74	S/O 1 Parity Check 0 = No 1 = Odd 2 = Even
75	S/O 1 Stop bit 0 = 1 stop bit 1 = 2 stop bit
76	S/O 1 Data Length 0 = 7 - bit 1 = 8 - bit
S/O 2 (Speed 9600bps Fix) Chosen option numbers of Flag #73 and #77 must be different each other.	
77	S/O 2 Peripheral 0 = Barcode Scanner 1 = PC
78	S/O 2 Parity Check 0 = No 1 = Odd 2 = Even
79	S/O 2 Stop bit 0 = 1 stop bit 1 = 2 stop bit
80	S/O 2 Data Length 0 = 7 - bit 1 = 8 - bit

FLAG NUMBER	DESCRIPTION
81	LANGUAGE 0 = English Mode 1 = Spanish Mode 2 = French Mode 3 = German Mode
82	CANADIAN TAX SYSTEM 0 = Disabled 1 = Canadian Tax System
83	Tax exempt amount 0 = Net 1 = Gross
84	Add tax 2 to tax 1 0 = Yes 1 = No
85	Add tax 3 to tax 1 0 = Yes 1 = No
86	Add tax 4 to tax 1 0 = Yes 1 = No
87	CHANGE KEY LAYOUT FOR FOOD STAMP 0 = Department 1 = Department 16 : Food Stamp Tend key Department 17 : Food Stamp Total key Department 18 : Food Shift key Department 19 : Non Food Stamp Shift key
88	FOOD STAMP ACCOUNT 0 = Food Stamp 1 = Debit (Food stamp account less than \$ available)
89	FOOD STAMP 0 = Non Taxable 1 = Taxable
HASH	
90	0 = Do not add Hash on all Transaction. 1 = Add Hash on all Transaction.

TO TAKE A FLAG REPORT

1. Turn the key to the "PRG" (PROGRAM) position.
2. If a Manager Password has been programmed, ENTER the (PASSWORD #), then PRESS the [CLERK] key, or if you did not program a Manager Password, go to Step 3.
3. ENTER [999999], then PRESS the [AMOUNT TEND/TOTAL] key.

PROGRAM CONFIRMATION REPORT

The Program Confirmation Report allows you to check your programming results.

TO TAKE A PROGRAM CONFIRMATION BASIC PRESET REPORT

"PRG" + (999999) + [AMOUNT TEND/TOTAL]

1. Turn the key to the "PRG" position as desired.
2. If a Manager Password has been programmed, ENTER the (PASSWORD #), then PRESS the [CLERK] key, or if you not program a Manager Password, go to Step 3.
3. PRESS (999999), then PRESS the [AMOUNT TEND/TOTAL] key.

The following illustrates the Program Confirmation Basic Preset Report. The figures shown in this example are randomly chosen:

	<pre> ***** YOUR RECEIPT Thank You Call again ***** BASIC PRESET FLAG OP 1-10 1020000000 11-20 0000000000 21-30 0000000000 31-40 0000000000 41-50 0000000000 51-60 0000000000 61-70 0000000000 71-80 0010010200 81-90 0000000000 TAX-1 0 0.0000% @0.00 TAX-2 0 0.0000% @0.00 TAX-3 0 0.0000% @0.00 TAX-4 0 0.0000% @0.00 COUPON FLAG COUPON F 0000 COUPON AMOUNT COUPON 0.00 MINUS % FLAG SETTING -% F 00 MINUS % DISCOUNT -% 0.00% PLUS % FLAG SETTING +% F 00 PLUS % DISCOUNT +% 0.00% TRANSACTION NUMBER CSCN 0001 MACHINE # MCNO 00 ROUNDING ROUND 0000 REPORT COUNTERS X1CNT 0001 X2CNT 0001 Z1CNT 0001 Z2CNT 0001 PROGRAM PASSWORD PROGRAM 0000 REPORT PASSWORD REPORT 0000 GRAND TOTAL NRGT 0.00 </pre>	
<p>FLAG OPTIONS</p> <p>TAX RATE</p> <p>COUPON FLAG</p> <p>COUPON AMOUNT</p> <p>MINUS % FLAG SETTING</p> <p>MINUS % DISCOUNT</p> <p>PLUS % FLAG SETTING</p> <p>PLUS % DISCOUNT</p> <p>TRANSACTION NUMBER</p> <p>MACHINE #</p> <p>ROUNDING</p> <p>REPORT COUNTERS</p> <p>PROGRAM PASSWORD</p> <p>REPORT PASSWORD</p> <p>GRAND TOTAL</p>	<p># OF LOGO LINE</p> <p>PROGRAMMED</p> <p>1st LOGO LINE</p> <p>2nd LOGO LINE</p> <p>3rd LOGO LINE</p> <p>4th LOGO LINE</p> <p>5th LOGO LINE</p> <p>6th LOGO LINE</p> <p>7th LOGO LINE</p> <p>8th LOGO LINE</p> <p>9th LOGO LINE</p> <p># OF MESSAGE LINE</p> <p>1-9 MESSAGE LINES</p> <p>SCROLL MESSAGE #1-4</p> <p>DISPLAY TIME</p> <p>TIME DISPLAY</p> <p>SCROLL FLAG</p> <p>SCROLL SPEED</p> <p>SCROLL MESSAGE #1-5</p>	<pre> LOGO LINE 5 LOGO 1 ***** LOGO 2 YOUR RECEIPT LOGO 3 Thank You Logo 4 Call Again Logo 5 ***** Logo 6 Logo 7 Logo 8 Logo 9 MESSAGE LINE 0 MESSAGE 1 MESSAGE 2 MESSAGE 3 MESSAGE 4 MESSAGE 5 MESSAGE 6 MESSAGE 7 MESSAGE 8 MESSAGE 9 SCR TBM 1 01 SCR TBM 2 10 SCR TBM 3 10 SCR TBM 4 10 T DISPLY 2 SCR FLAG 0 SCR SPD 2 SCR1 CLOSED, NEXT REGIS TER PLEASE SCR2 PLEASE WAIT SCR3 PLEASE TAKE YOUR R ECEIPT SCR4 GOOD MORNING SCR5 GOOD AFTERNOON </pre>

(Continued) PROGRAM CONFIRMATION REPORT

TO TAKE A CLERK CONFIRMATION REPORT

"PRG" + [PLU/DEPT ALT] + [CLERK]

1. Turn the key to the "PRG" position as desired.
2. If a Manager Password has been programmed, ENTER the (PASSWORD #), then PRESS the [CLERK] key, or if you not program a Manager Password, go to Step 3.
3. PRESS [PLU/DEPT ALT] , then PRESS the [CLERK] key.

Important: A Clerk Reading must be closed out in the "Z" position.

	CLERK PRESET	
CLERK NUMBER	CLERK 01	1111
CLERK NO	TOM	
	CLERK 02	2222
	JOAN	
	CLERK 03	3333
	MARY	
	CLERK 04	4444
	JOE	
	CLERK 05	0005
	CLERK05	
	CLERK 06	0006
	CLERK06	
	CLERK 07	0007
	CLERK07	
	CLERK 08	0008
	CLERK08	
	CLERK 09	0009
	CLERK09	
	CLERK 10	0010
	CLERK10	
	CLERK 11	0010
	CLERK11	
	CLERK 12	0012
	CLERK12	
	CLERK 13	0013
	CLERK13	
	CLERK 14	0014
	CLERK14	
	CLERK 15	0015
	CLERK15	

CLERK PASSWORD

PROGRAM CONFIRMATION REPORT (Continued)

TO TAKE A DEPARTMENT REPORT

"PRG" + [PLU/DEPT ALT] + [DEPT]

DEPARTMENT NUMBER	DEPT PRESET	DEPARTMENT NAME	
01	DEPT01		
	PRICE	1.99	PRE-SET PRICE
	FLAG	000000001	DEPARTMENT FLAG OPTIONS
02	DEPT02		
	PRICE	2.50	
	FLAG	000000000	
03	DEPT03		
	PRICE	3.00	
	FLAG	000000001	
04	DEPT04		
	PRICE	0.00	
	FLAG	000000000	
05	DEPT05		
	PRICE	0.00	
	FLAG	000000000	
06	DEPT06		
	PRICE	0.00	
	FLAG	000000000	
07	DEPT07		
	PRICE	0.00	
	FLAG	000000000	
08	DEPT08		
	PRICE	0.00	
	FLAG	000000000	
09	DEPT09		
	PRICE	0.00	
	FLAG	000000000	
10	DEPT10		
	PRICE	0.00	
	FLAG	000000000	

NOTE: If a description has been programmed, the name will print instead of the Dept. #

TRANSACTION EXAMPLES FOR OPERATING THE CASH REGISTER

The examples in this section show how to ring up different types of transactions. A maximum of 7 digits may be used to enter a price.

NOTE: Turn the key to the "REG" (REGISTER) position for registering sales transactions.
IMPORTANT: It is not necessary to press the Decimal Point when ringing up a price.
REMINDER: If Clerk Numbers are programmed, be sure to **ENTER** the (CLERK #), then **PRESS** the [CLERK] key before ringing up a sale.

SAMPLE RECEIPT

The sample receipt below illustrates general transaction information you will see printed on a receipt:

	TAX RATE APPLIED				
DEPARTMENT #	DEPT01	I	1.00		
	DEPT02		2.99		
	SUB-TTL		3.99		
QUANTITY SOLD	ITEM CT	2			
	TAX		0.06		
	TOTAL		4.05		
CASH TENDERED	CASH TD		10.00		
	CHANGE		5.95		
DATE	10-24-2002	PM 03:49		TIME	
		0002			
	CLERK01				
	CLERK NAME	TRANSACTION #			

TRANSACTION SYMBOLS: The following symbols will appear on transaction receipts:

<p>Name or No. 1 to No. 40: 1 Through 40 Clerks CASH: Cash Transaction Total CHECK: Check Transaction Total CHARGE: Charge Transaction Total SUB-TTL: Subtotal (Excludes Tax) TOTAL: Total of Sale CHANGE: Change Q: Number of Items Being Multiplied @: Dollar Amount Being Multiplied I : Tax 1 Rate Applied to a Sale II: Tax 2 Rate Applied to a Sale N: Number of Transactions X or Z Report CASH TD: Amount Tendered -%: Minus Percent Discount +%: Plus Percent</p>	<p>NO SALE: No-Sale Function or Open Cash Drawer indicates when #/ST/NS is pressed. VOID: Void RETURN: Return (Refund) COUPON: Prints When the -/CPN R/A: Received on Account P/O: Paid Out PLU: Followed by a 1-3 digit number on the left side of the receipt and the amount on the right side represents a PLU #, or a description that has been programmed ITEM CT: Quantity of Items Sold</p>
---	---

TRANSACTION EXAMPLES FOR OPERATING THE CASH REGISTER

NOTE: Turn the key to the "REG" (REGISTER) position for registering sales transactions.
IMPORTANT: It is not necessary to press the Decimal Point when ringing up a price.
REMINDER: If Clerk Numbers are programmed, be sure to **ENTER** the (CLERK #), then **PRESS** the [CLERK] key before ringing up a sale.

In the examples below, Department 1 is programmed as taxable with a 6% (TAX 1) rate and Clerk #1 is used.

EXAMPLE 1: CASH SALE WITHOUT TENDERING CHANGE - (Ring up a \$1.00 item in Department 1):

1. **ENTER (100)**, then **PRESS** the [DEPARTMENT 1] key.
2. **PRESS** the [#ST/NS] key. The #/ST/NS key does not need to be depressed if you do not want the subtotal of a sale to print.
3. **PRESS** the [SUBTOTAL W/TAX] key.
4. **PRESS** the [AMOUNT TEND/TOTAL] key.

DEPT01 I	1.00
SUB-TTL	1.00
ITEM CT	1
TAX	0.06
CASH	1.06

EXAMPLE 2: CASH SALE WITH TENDERING CHANGE - (Ring up a \$1.00 item in Department 1 and compute change from \$5.00 cash tendered):

1. **ENTER (100)**, then **PRESS** the [DEPARTMENT 1] key.
2. **PRESS** the [#ST/NS] key. The #/ST/NS key does not need to be depressed if you do not want the subtotal of a sale to print.
3. **PRESS** the [SUBTOTAL W/TAX] key.
4. **ENTER (500)**, then **PRESS** the [AMOUNT TEND/TOTAL] key.

DEPT01 I	1.00
SUB-TTL	1.00
ITEM CT	1
TAX	0.06
TOTAL	1.06
CASH TD	5.00
CHANGE	3.94

EXAMPLE 3: USING THE DEPT KEY AND TENDERING CHANGE - (Ring up a \$1.00 item in Department 1, \$2.00 in Department 2 and \$3.00 in Department 21 and compute change from \$10.00 cash tendered):

1. **ENTER (100)**, and then **PRESS** the [DEPARTMENT 1] key.
2. **ENTER (200)**, then **PRESS** the [DEPARTMENT 2] key.
3. **ENTER (300)**, then **PRESS** the [PLU/DEPT ALT] (21)[DEPT] key.
4. **PRESS** the [SUBTOTAL W/TAX] key.
5. **ENTER (1000)**, then **PRESS** the [AMOUNT TEND/TOTAL] key.

DEPT01 I	1.00
DEPT02	2.00
DEPT21	3.00
ITEM CT	3
TAX	0.06
TOTAL	6.06
CASH TD	10.00
CHANGE	3.94

TRANSACTION EXAMPLES FOR OPERATING THE CASH REGISTER

NOTE: Turn the key to the "REG" (REGISTER) position for registering sales transactions.
IMPORTANT: It is not necessary to press the Decimal Point when ringing up a price.
REMINDER: If Clerk Numbers are programmed, be sure to **ENTER** the (CLERK #), then **PRESS** the [CLERK] key before ringing up a sale.

In the examples below, Department 1 is programmed as taxable with a 6% (TAX 1) rate and Clerk #1 is used.

EXAMPLE 4: CHARGE SALE - (Ring up a \$1.00 item in Department 1 and finalize the sale with the CHARGE key):

1. **ENTER (100)**, then **PRESS** the [DEPARTMENT 1] key.
2. **PRESS** the [CHARGE] key. It is not necessary to enter any amounts before pressing the Charge key.

DEPT01 I	1.00
ITEM CT	1
TAX	0.06
CHARGE	1.06

EXAMPLE 5: CHECK SALE - (Ring up a \$1.00 item in Department 1 and finalize the sale with the CHECK key):

1. **ENTER (100)**, then **PRESS** the [DEPARTMENT 1] key.
2. **PRESS** the [CHECK/STUB] key. When needing to tender change with the Check key, enter the amount of the check before pressing the Check key.

DEPT01	1.00
ITEM CT	1
TAX	0.06
CHECK	1.06

EXAMPLE 6: SPLIT TENDERING SALE - (Ring up a \$15.00 item in Department 1, split the total of the sale between \$5.00 in cash payment and \$10.90 in charge payment):

1. **ENTER (1500)**, then **PRESS** the [DEPARTMENT 1] key.
2. **PRESS** the [SUBTOTAL W/TAX] key.
3. **ENTER (500)**, then **PRESS** the [AMOUNT TEND/TOTAL] key.
4. **PRESS** the [CHARGE] key.

DEPT01 I	15.00
ITEM CT	1
TAX	0.90
TOTAL	15.90
CASH TD	5.00
CHARGE	10.90

Note: In using the Split Tendering function, the amount in cash must always be registered first. Split Tendering can also be finalized with the Check key. Simply substitute the Check key in Step 4 of this example.

TRANSACTION EXAMPLES FOR OPERATING THE CASH REGISTER

NOTE: Turn the key to the "REG" (REGISTER) position for registering sales transactions.
IMPORTANT: It is not necessary to press the Decimal Point when ringing up a price.
REMINDER: If Clerk Numbers are programmed, be sure to **ENTER** the (CLERK #), then **PRESS** the [CLERK] key before ringing up a sale.

In the examples below, Department 1 is programmed as taxable with a 6% (TAX 1) rate and Clerk #1 is used.

EXAMPLE 7: NO-SALE FUNCTION - (Used primarily to open the drawer without ringing up a sale. For example, to give change):

1. **PRESS** the [#ST/NS] key.

NOSALE	0#
--------	----

Note: The number of times the No-Sale key is will be monitored on the Management Reports.

EXAMPLE 8: REGISTERING A REFERENCE NUMBER - (Used to print a number, up to 8 digits, to identify an invoice number, credit card number or any other number on receipts. Ring up the number 12345678 in a standard sale):

1. **ENTER (12345678)**, **PRESS** the [#ST/NS] key.
2. **ENTER (100)**, **PRESS** the [DEPARTMENT 1] key.
3. **PRESS** the [AMOUNT TEND/TOTAL] key.

	12345678#
DEPT01 I	1.00
ITEM CT	1
TAX	0.06
CASH	1.06

Note: The use of the reference number is not in any activity counter or sales totals on the Management Reports.

EXAMPLE 9: MULTIPLYING BY A FRACTION - (Multiply the quantity of 1.25, i.e., 1¼ yards of fabric at \$1.00 in Department 1):

1. **ENTER (1.25)**, then **PRESS** the [QTY/TIME] key.
Note: When multiplying by a fraction it is necessary to use the decimal point.
2. **ENTER (100)**, then **PRESS** the [DEPARTMENT 1] key.
3. **PRESS** the [AMOUNT TEND/TOTAL] key.

	1.25Q	@1.00
DEPT01 I		1.25
ITEM CT		1.25
TAX		0.07
CASH		1.32

Note: The range of numbers from .01 to 9999.99 can be used when ringing up the quantity of an item.

TRANSACTION EXAMPLES FOR OPERATING THE CASH REGISTER

NOTE: Turn the key to the "REG" (REGISTER) position for registering sales transactions.
IMPORTANT: It is not necessary to press the Decimal Point when ringing up a price.
REMINDER: If Clerk Numbers are programmed, be sure to **ENTER** the (CLERK #), then **PRESS** the [CLERK] key before ringing up a sale.

In the examples below, Department 1 is programmed as taxable with a 6% (TAX 1) rate and Clerk #1 is used.

EXAMPLE 10: **MULTIPLICATION SALE** - (Ring up a \$1.00 item 3 times in Department 1):

1. **ENTER (3)**, then **PRESS** the [QTY/TIME] key.
2. **ENTER (100)**, then **PRESS** the [DEPARTMENT 1] key.
3. **PRESS** the [AMOUNT TEND/TOTAL] key.

Note: The range of numbers from .01 to 9999.99 can be used when ringing up the quantity of an item.

	3Q	@1.00
DEPT01	I	3.00
ITEM CT		3
TAX		0.18
CASH		3.18

EXAMPLE 11: **REGISTERING A DEPARTMENT UNIT PRICE** - (Assume Department 1 is pre-programmed for \$1.00. Ring up this price):

1. **PRESS** the [DEPARTMENT 1] key.
2. **PRESS** the [AMOUNT TEND/TOTAL] key.

DEPT01	I	1.00
ITEM CT		1
TAX		0.06
CASH		1.06

EXAMPLE 12: **MULTIPLICATION OF A DEPARTMENT UNIT PRICE** - (Assume the Department 1 key is pre-programmed for \$1.00. Ring up this price three times):

1. **ENTER (3)**, then **PRESS** the [QTY/TIME] key.
2. **PRESS** the [DEPARTMENT 1] key.
3. **PRESS** the [AMOUNT TEND/TOTAL] key.

	3Q	@1.00
DEPT01	I	3.00
ITEM CT		3
TAX		0.18
CASH		3.18

TRANSACTION EXAMPLES FOR OPERATING THE CASH REGISTER

NOTE: Turn the key to the "REG" (REGISTER) position for registering sales transactions.
IMPORTANT: It is not necessary to press the Decimal Point when ringing up a price.
REMINDER: If Clerk Numbers are programmed, be sure to **ENTER** the (CLERK #), then **PRESS** the [CLERK] key before ringing up a sale.

In the examples below, Department 1 is programmed as taxable with a 6% (TAX 1) rate and Department 2 is programmed for no tax and Clerk #1 is used.

EXAMPLE 13: **DEPARTMENT** - (Assume the DEPT 99 is preset for the price of \$1.00. Ring up the DEPT # 99):

1. **ENTER (99)**, then **PRESS** the [DEPT] key.
2. **PRESS** the [AMOUNT TEND/TOTAL] key

DEPT99	1.00
ITEM CT	1
CASH	1.00

EXAMPLE 14: **EXEMPTING TAX ON AN ITEM** - (Assume the Department 1 key is programmed as a taxable department. Ring up a \$1.00 item in Department 1 without charging tax):

1. **PRESS** the [NON TAX] key.
2. **ENTER (100)**, then **PRESS** the [DEPARTMENT 1] key.
3. **PRESS** the [AMOUNT TEND/TOTAL] key.

DEPT01	1.00
ITEM CT	1
CASH	1.00

EXAMPLE 15: **ADDING TAX TO A NON TAXABLE DEPARTMENT** - (Assume the Department 2 key is programmed for no tax and the Department 1 key is programmed with a 6% TAX 1 tax rate. Ring up a \$1.00 item in Department 2, charging the 6% tax rate):

1. **PRESS** the [TAX 1] key.
2. **ENTER (100)**, then **PRESS** the [DEPARTMENT 2] key.
3. **PRESS** the [AMOUNT TEND/TOTAL] key.

DEPT02 I	1.00
ITEM CT	1
TAX	0.06
CASH	1.06

TRANSACTION EXAMPLES FOR OPERATING THE CASH REGISTER

NOTE: Turn the key to the "REG" (REGISTER) position for registering sales transactions.
IMPORTANT: It is not necessary to press the Decimal Point when ringing up a price.
REMINDER: If Clerk Numbers are programmed, be sure to **ENTER** the (CLERK #), then **PRESS** the [CLERK] key before ringing up a sale.

In the examples below, Department 1 is programmed as taxable with a 6% (TAX 1) rate and Clerk #1 is used.

EXAMPLE 16: RECEIVED-ON-ACCOUNT SALE - ("Indicates money put in the cash drawer." Ring up \$50.00 to show the beginning cash-in-drawer amount for the day):

1. **ENTER (5000)**, then **PRESS** the [RA] key.
2. **PRESS** the [AMOUNT TEND/TOTAL] key.

R/A		50.00
R/A CA		50.00

Note: A Received-On-Account Sale can also be finalized with the CHECK key. This function cannot be performed in the middle of a sales transaction.

EXAMPLE 17: PAID-OUT SALE - (Indicates money taken out of the cash drawer." Ring up \$10.00 to show money paid out of the cash drawer):

1. **ENTER (1000)**, then **PRESS** the [PO] key.
2. **PRESS** the [AMOUNT TEND/TOTAL] key.

P/O		10.00
P/O CA		10.00

Note: A Paid-Out sale can also be finalized with the CHARGE and CHECK keys. This function cannot be performed in the middle of a sales transaction.

EXAMPLE 18: RETURN SALE - (Refund a \$1.00 item in Department 1 and refund a \$1.50 item three times in Department 1):

1. **PRESS** the [RETURN] key.
2. **ENTER (100)**, then **PRESS** the [DEPARTMENT 1] key.
3. **PRESS** the [RETURN] key.
4. **ENTER (3)**, then **PRESS** the [QTY/TIME] key.
5. **ENTER (150)**, then **PRESS** the [DEPARTMENT 1] key.
6. **PRESS** the [AMOUNT TEND/TOTAL] key.

RETURN		
DEPT01	I	1.00
RETURN		
	3Q	@1.50
DEPT01	I	4.50
ITEM CT		0
TAX		-0.33
CASH		-5.83

Note: The Return function can be performed in the middle of a sales transaction or by itself in a transaction.

TRANSACTION EXAMPLES FOR OPERATING THE CASH REGISTER

NOTE: Turn the key to the "REG" (REGISTER) position for registering sales transactions.
IMPORTANT: It is not necessary to press the Decimal Point when ringing up a price.
REMINDER: If Clerk Numbers are programmed, be sure to **ENTER** the (CLERK #), then **PRESS** the [CLERK] key before ringing up a sale.

In the examples below, Department 1 is programmed as taxable with a 6% (TAX 1) rate and Department 2 is programmed for no tax and Clerk #1 is used.

EXAMPLE 19: COUPON DISCOUNT SALE:

There are various versions of ringing up a Coupon Discount sale. Based on the option selected for the flag settings (refer to Pages 33-35 for details on programming), choose the example below which best serves your needs:

VERSION 1: In the following three examples, the flag settings for the Coupon key are programmed for all "0".

- a. If no tax is programmed in your cash register, ring up a \$1.00 item in Department 2 and then deduct the 20¢ coupon:

1. **ENTER (100)**, then **PRESS** the [DEPARTMENT 2] key.
2. **ENTER (20)**, then **PRESS** the [-/CPN] key.
3. **PRESS** the [AMOUNT TEND/TOTAL] key.

DEPT02	1.00
COUPON N	0.20
ITEM CT	1
CASH	0.80

- b. If you want to charge the tax rate on the original amount of an item (the amount before the coupon is deducted), ring up a \$1.00 item in Department 1 (programmed for Tax 1 - 6%), press [#/ST/NS] and then deduct the 20¢ coupon:

1. **ENTER (100)**, then **PRESS** the [DEPARTMENT 1] key.
2. **PRESS** the [#/ST/NS] key.
3. **ENTER (20)**, then **PRESS** the [-/CPN] key.
4. **PRESS** the [AMOUNT TEND/TOTAL] key.

DEPT01 I	1.00
SUB-TTL	1.00
COUPON G	0.20
ITEM CT	1
TAX	0.06
CASH	0.86

- c. If you want to charge the tax rate on the discounted amount of an item (the amount after the coupon is deducted), ring up a \$1.00 item in Department 1 and then deduct the 20¢ coupon:

1. **ENTER (100)**, then **PRESS** the [DEPARTMENT 1] key.
2. **ENTER (20)**, then **PRESS** the [-/CPN] key.
3. **PRESS** the [AMOUNT TEND/TOTAL] key.

DEPT01 I	1.00
COUPON N I	0.20
ITEM CT	1
TAX	0.04
CASH	0.84

TRANSACTION EXAMPLES FOR OPERATING THE CASH REGISTER

NOTE: Turn the key to the "REG" (REGISTER) position for registering sales transactions.
IMPORTANT: It is not necessary to press the Decimal Point when ringing up a price.
REMINDER: If Clerk Numbers are programmed, be sure to **ENTER** the (CLERK #), then **PRESS** the [CLERK] key before ringing up a sale.

In the examples below, Department 1 is programmed as taxable with 6% (TAX 1) rate and Department 2 is programmed for no tax and Clerk #1 is used.

EXAMPLE 20: MINUS PERCENTAGE DISCOUNT SALE:

There are various versions of ringing up a Minus Percentage Discount sale based on the option selected for the flag settings (refer to Page 36 for details on programming). Choose the example below which best serves your needs:

VERSION 1: In the following two examples, the flag settings for the Minus Percentage Discount Key are programmed for all "0":

- a. If no tax is programmed in your cash register, ring up a \$1.00 item in Department 2 and apply a pre-programmed discount rate of 10%:

1. **ENTER (100)**, then **PRESS** the [DEPARTMENT 2] key.
2. **PRESS** the [-%] key. If the Minus Percentage Discount Rate is NOT programmed, type in the discount rate before pressing the [-%] key.
3. **PRESS** the [AMOUNT TEND/TOTAL] key.

DEPT02		1.00
	10 -%N	0.10
ITEM CT		1
CASH		0.90

- b. If you want to charge the tax rate on the discounted amount of an item (the amount after the percentage discount is deducted), ring up a \$1.00 item in Department 1 and apply a pre-programmed discount rate of 10%:

1. **ENTER (100)**, then **PRESS** the [DEPARTMENT 1] key.
2. **PRESS** the [-%] key. If the Minus Percentage Discount Rate is NOT pre-programmed, type in the discount rate before pressing the [-%] key.
3. **PRESS** the [AMOUNT TEND/TOTAL] key.

DEPT01	I	1.00
	10 -%N	0.10
ITEM CT		1
TAX		0.05
CASH		0.95

VERSION 2: In the following example, the flag settings for the Minus Percentage Discount Key are programmed for "10%".

If you want to charge the tax rate on the original amount of an item (the amount before the percentage discount is deducted), ring up a \$1.00 item in Department 1 and apply a pre-programmed discount rate of 10%:

1. **ENTER (100)**, then **PRESS** the [DEPARTMENT 1] key.
2. **PRESS** the [#ST/NS] key.
3. **PRESS** the [-%] key. If the Minus Percentage Discount Rate is NOT pre-programmed, type in the discount rate before pressing the [-%] key.
4. **PRESS** the [AMOUNT TEND/TOTAL] key.

DEPT01	I	1.00
SUB-TTL		1.00
	10 -%G	0.10
ITEM CT		1
TAX		0.05
CASH		0.95

TRANSACTION EXAMPLES FOR OPERATING THE CASH REGISTER

NOTE: Turn the key to the "REG" (REGISTER) position for registering sales transactions.
IMPORTANT: It is not necessary to press the Decimal Point when ringing up a price.
REMINDER: If Clerk Numbers are programmed, be sure to **ENTER** the (CLERK #), then **PRESS** the [CLERK] key before ringing up a sale.

In the examples below, Department 1 is programmed as taxable with a 6% (TAX 1) rate and Department 2 is programmed for no tax and Clerk #1 is used.

EXAMPLE 21: PLUS PERCENTAGE SALE:

There are various methods of ringing up a Plus Percentage Sale based on the option selected for the flag settings (refer to Page 37 for details on programming). Choose the example below which best serves your needs:

VERSION 1: In the following two examples, the flag settings for the Plus Percentage are programmed for all "0":

- a. If no tax is programmed in your cash register, ring up a \$1.00 item in Department 2 and apply a pre-programmed Plus Percentage Rate of 10%:

1. **ENTER (100)**, then **PRESS** the [DEPARTMENT 2] key.
2. **PRESS** the [+%] key. If the Plus Percentage Rate is NOT pre-programmed, type in the plus percentage rate before pressing the [+%] key.
3. **PRESS** the [AMOUNT TEND/TOTAL] key.

DEPT02		1.00
	10 +%N	0.10
ITEM CT	1	
CASH		1.10

- b. If you want to charge the tax rate on the amount after the Plus Percentage is added, ring up a \$1.00 item in Department 1 and apply a pre-programmed Plus Percentage Rate of 10%:

1. **ENTER (100)**, then **PRESS** the [DEPARTMENT 1] key.
2. **PRESS** the [+%] key. If the Plus Percentage Rate is NOT pre-programmed, type in the Plus Percentage Rate before pressing the [+%] key.
3. **PRESS** the [AMOUNT TEND/TOTAL] key.

DEPT01 I		1.00
	10 +%N	0.10
ITEM CT	1	
TAX		0.06
CASH		1.16

VERSION 2: In the following example, the flag settings for the Plus Percentage Key are programmed for "100":

If you want to charge the tax rate on the original amount of an item (the amount before the Plus Percentage is added), ring up a \$1.00 item in Department 1 and apply a pre-programmed Plus Percentage Rate of 10%:

1. **ENTER (100)**, then **PRESS** the [DEPARTMENT 1] key.
2. **PRESS** the [#ST/NS] key.
3. **PRESS** the [+%] key. If the Plus Percentage Rate is NOT pre-programmed, type in the plus percentage rate before pressing the [+%] key.
4. **PRESS** the [AMOUNT TEND/TOTAL] key.

DEPT01 I		1.00
SUB-TTL		1.00
	10 +%G	0.10
ITEM CT	1	
TAX		0.06
CASH		1.16

TRANSACTION EXAMPLES FOR OPERATING THE CASH REGISTER

NOTE: Turn the key to the "REG" (REGISTER) position for registering sales transactions.
IMPORTANT: It is not necessary to press the Decimal Point when ringing up a price.
REMINDER: If Clerk Numbers are programmed, be sure to **ENTER** the (CLERK #), then **PRESS** the [CLERK] key before ringing up a sale.

In the examples below, Department 1 is programmed as taxable with a 6% (TAX 1) rate and Clerk #1 is used.

EXAMPLE 22: USE OF THE ERROR-CORRECT [EC] KEY:

Corrects the last entry rung up during a sale. Ring up a \$1.00 item in Department 1, then use the [EC] key to cancel this entry and ring up a \$10.00 item in Department 1 to register a new entry:

1. **ENTER (100)**, then **PRESS** the [DEPARTMENT 1] key.
2. **PRESS** the [EC] key.
3. **ENTER (1000)**, then **PRESS** the [DEPARTMENT 1] key.
4. **PRESS** the [AMOUNT TEND/TOTAL] key.

DEPT01 I	1.00
	-VOID-
DEPT01 I	1.00
DEPT01 I	10.00
ITEM CT	1
TAX	0.60
CASH	10.60

EXAMPLE 23: VOIDING A SALE - (Void a \$1.00 item in Department 1):

1. **ENTER (100)**, **PRESS** the [VOID] key, then **PRESS** the [DEPARTMENT 1] key.
2. **PRESS** the [AMOUNT TEND/TOTAL] key.

	-VOID-
DEPT01 I	1.00
ITEM CT	-1
TAX	-0.06
CASH	-1.06

EXAMPLE 24: VOIDING A MULTIPLICATION SALE - (Void a \$1.00 item in Department 1 three times):

1. **ENTER (3)**, then **PRESS** the [QTY/TIME] key.
2. **ENTER (100)**, **PRESS** the [VOID] key, then **PRESS** the [DEPARTMENT 1] key.
3. **PRESS** the [AMOUNT TEND/TOTAL] key.

	-VOID-
	3Q @1.00
DEPT01 I	3.00
ITEM CT	-3
TAX	-0.18
CASH	-3.18

TRANSACTION EXAMPLES FOR OPERATING THE CASH REGISTER

NOTE: Turn the key to the "REG" (REGISTER) position for registering sales transactions.
IMPORTANT: It is not necessary to press the Decimal Point when ringing up a price.
REMINDER: If Clerk Numbers are programmed, be sure to **ENTER** the (CLERK #), then **PRESS** the [CLERK] key before ringing up a sale.

In the examples below, Department 1 is programmed as taxable with a 6% (TAX 1) rate and Clerk #1 is used.

EXAMPLE 25: VOIDING A COUPON SALE - (Void a \$1.00 item in Department 1, void a 20¢ coupon):

1. **ENTER (100)**, **PRESS** the [VOID] key, then **PRESS** the [DEPARTMENT 1] key.
2. **ENTER (20)**, **PRESS** the [VOID] key, then **PRESS** the [-/CPN] key.
3. **PRESS** the [AMOUNT TEND/TOTAL] key.

	-VOID-	
DEPT01	I	1.00
	-VOID-	
COUPON	N I	0.20
ITEM CT		-1
TAX		-0.04
CASH		-0.84

EXAMPLE 26: VOIDING A MINUS PERCENTAGE DISCOUNT SALE - (Void a \$1.00 item in Department 1 and void a pre-programmed Minus Percentage Discount Rate of 10%):

1. **ENTER (100)**, **PRESS** the [VOID] key, then **PRESS** the [DEPARTMENT 1] key.
2. **[PRESS]** the [-%] key.
If the Minus Percentage Discount Rate is not pre-programmed, type in the discount rate before pressing the [-%] key.
3. **PRESS** the [AMOUNT TEND/TOTAL] key.

	-VOID-	
DEPT01	I	1.00
	10 -%N	-0.10
ITEM CT		-1
TAX		-0.05
CASH		-0.95

EXAMPLE 27: VOIDING A PLUS PERCENTAGE SALE - (Void a \$1.00 item in Department 1 and void a pre-programmed Plus Percentage Rate of 10%):

1. **ENTER (100)**, **PRESS** the [VOID] key, then **PRESS** the [DEPARTMENT 1] key.
2. **[PRESS]** the [+%] key.
If the Plus Percentage Discount Rate is not pre-programmed, type in the discount rate before pressing the [+%] key.
3. **PRESS** the [AMOUNT TEND/TOTAL] key.

	-VOID-	
DEPT01	I	1.00
	10 +%N	-0.10
ITEM CT		-1
TAX		-0.06
CASH		-1.16

TRANSACTION EXAMPLES FOR OPERATING THE CASH REGISTER

NOTE: Turn the key to the "REG" (REGISTER) position for registering sales transactions.
IMPORTANT: It is not necessary to press the Decimal Point when ringing up a price.
REMINDER: If Clerk Numbers are programmed, be sure to **ENTER** the (CLERK #), then **PRESS** the [CLERK] key before ringing up a sale.

In the examples below, Department 1 is programmed as taxable with a 6% (TAX 1) rate and Department 2 is programmed for no tax and Clerk #1 is used.

EXAMPLE 28: VOIDING A DEPARTMENT PRESET PRICE - (Assume Department 1 is programmed for the price of \$1.00 and Department 2 is programmed for the price of \$2.00. Ring up Department 1 and Department 2 prices, then void the Department 1 entry):

1. **PRESS** the [DEPARTMENT 1] key.
2. **PRESS** the [DEPARTMENT 2] key.
3. **ENTER (100)**, **PRESS [VOID]**, then **PRESS** the [DEPARTMENT 1] key.
4. **PRESS** the [AMOUNT TEND/TOTAL] key.

DEPT01	I		1.00
DEPT02			2.00
		-VOID-	
DEPT01	I		1.00
ITEM CT		1	
CASH			2.00

EXAMPLE 29: VOIDING MULTIPLICATION OF A DEPARTMENT PRESET PRICE - (Assume Department 1 is programmed for the price of \$1.00 and Department 2 is programmed for the price of \$2.00. Ring up Department 1 three times and Department 2 two times, then void the Department 1 entry rung up three times):

1. **ENTER (3)**, then **PRESS** the [QTY/TIME] key.
2. **PRESS** the [DEPARTMENT 1] key.
3. **ENTER (2)**, then **PRESS** the [QTY/TIME] key.
4. **PRESS** the [DEPARTMENT 2] key.
5. **ENTER (3)**, then **PRESS** the [QTY/TIME] key.
6. **PRESS** the [VOID] key.
7. **PRESS** the [DEPARTMENT 1] key.
8. **PRESS** the [AMOUNT TEND/TOTAL] key.

		3Q	@1.00
DEPT01	I		3.00
		2Q	@2.00
DEPT02			4.00
		-VOID-	
		3Q	@1.00
DEPT01	I		3.00
ITEM CT		2	
CASH			4.00

TRANSACTION EXAMPLES FOR OPERATING THE CASH REGISTER

NOTE: Turn the key to the "REG" (REGISTER) position for registering sales transactions.
IMPORTANT: It is not necessary to press the Decimal Point when ringing up a price.
REMINDER: If Clerk Numbers are programmed, be sure to **ENTER** the (CLERK #), then **PRESS** the [CLERK] key before ringing up a sale.

In the examples below, Department 1 is programmed as taxable with a 6% (TAX 1) rate and Department 2 is programmed for no tax and Clerk #1 is used.

EXAMPLE 30: VOIDING A DEPARTMENT PRESET PRICE WITH A MINUS PERCENTAGE DISCOUNT -
 (Assume Department 1 is programmed for \$1.00, Department 2 is programmed for \$2.00, and the [PO/-%] key is pre-programmed for 10%. Ring up Department 1 and deduct 10%, ring up Department 2 and deduct 10%, then void the Department 1 entry with the 10% discount):

1. **PRESS** the [DEPARTMENT 1] key, then **PRESS** the [-%] key.
2. **PRESS** the [DEPARTMENT 2] key, then **PRESS** the [-%] key.
3. **ENTER (100)**, then **PRESS** the [VOID] key.
4. **PRESS** [DEPARTMENT 1], then **PRESS** the [-%] key.
5. **PRESS** the [AMOUNT TEND/TOTAL] key.

DEPT01	I	1.00
	10 -%N	0.10
DEPT02		2.00
	10 -%N	0.20
	-VOID-	
DEPT01	I	1.00
	10 -%N	-0.10
CASH		1.80

EXAMPLE 31: VOIDING A DEPARTMENT PRESET PRICE WITH A COUPON DISCOUNT - (Assume Department 1 is programmed for \$1.00 and Department 2 is programmed for \$2.00. Ring up Department 1 and deduct 20¢, ring up Department 2 and deduct 20¢, then void the Department 1 entry with the 20¢ coupon discount):

1. **PRESS** the [DEPARTMENT 1] key.
2. **ENTER (20)**, then **PRESS** the [-/CPN] key.
3. **PRESS** the [DEPARTMENT 2] key.
4. **ENTER (20)**, then **PRESS** the [-/CPN] key.
5. **ENTER (100)**, **PRESS** [VOID], then **PRESS** the [DEPARTMENT 1] key.
6. **ENTER (20)**, **PRESS** the [VOID] key, then **PRESS** the [-/CPN] key.
7. **PRESS** the [AMOUNT TEND/TOTAL] key.

DEPT01	I	1.00
COUPON	N I	0.20
DEPT02		2.00
COUPON	N	0.20
	-VOID-	
DEPT01	I	1.00
	-VOID-	
COUPON	N I	0.20
ITEM CT		1
CASH		1.80

TRANSACTION EXAMPLES FOR OPERATING THE CASH REGISTER

NOTE: Turn the key to the "REG" (REGISTER) position for registering sales transactions.
IMPORTANT: It is not necessary to press the Decimal Point when ringing up a price.
REMINDER: If Clerk Numbers are programmed, be sure to **ENTER** the (CLERK #), then **PRESS** the [CLERK] key before ringing up a sale.

In the examples below, Department 1 is programmed as taxable with a 6% (TAX 1) rate and Clerk #1 is used.

EXAMPLE 32: PLU SALE - (Assume the PLU # is preset for the price of \$1.00 in Department 1. Ring up the PLU #1):

1. **ENTER (1)**, then **PRESS** the [PLU] key.
2. **PRESS** the [AMOUNT TEND/TOTAL] key.

Note: PLUs follow the same procedure for ringing up Coupons, Refunds, Minus Percentage Discounts, Plus Percentages, etc. as described throughout the section for Transaction Examples For Operating The Cash Register.

PLU 0001 I	1.00
ITEM CT	1
TAX	0.06
CASH	1.06

Temporarily overriding a PLU PRICE: If you would like to enter a different price than what is programmed into a PLU #: **ENTER** the (DESIRED PRICE), **PRESS** the [PLU/DEPT ALT] key, **ENTER** the (PLU #), then **PRESS** the [PLU] key.

EXAMPLE 33: VOIDING A PLU SALE - (Assume PLU #1 is preset for the price of \$1.00 in Department 1. Void PLU #1):

1. **ENTER (1)**, **PRESS** the [VOID] key, then **PRESS** the [PLU] key.
2. **PRESS** the [AMOUNT TEND/TOTAL] key.

	-VOID-	
PLU 0001 I	1.00	
ITEM CT	-1	
TAX	-0.06	
CASH	-1.06	

EXAMPLE 34: VOIDING A PLU MULTIPLICATION SALE - (Assume PLU #1 is preset for the price of \$1.00 in Department 1. Void PLU #1 three times):

1. **PRESS** the [VOID] key, **ENTER (3)**, then **PRESS** the [QTY/TIME] key.
2. **ENTER (1)**, then **PRESS** the [PLU] key.
3. **PRESS** the [AMOUNT TEND/TOTAL] key.

	-VOID-	
3Q	@1.00	
PLU 0001 I	3.00	
ITEM CT	-3	
TAX	-0.18	
CASH	-3.18	

NOTE : If registering with the barcode reader is difficult by some reason, it is possible to enter the barcode number string from the keyboard. (Barcode) + [PLU]

TRANSACTION EXAMPLES FOR OPERATING THE CASH REGISTER

NOTE: Turn the key to the "REG" (REGISTER) position for registering sales transactions.
IMPORTANT: It is not necessary to press the Decimal Point when ringing up a price.
REMINDER: If Clerk Numbers are programmed, be sure to **ENTER** the (CLERK #), then **PRESS** the [CLERK] key before ringing up a sale.

In the examples below, Department 1 is programmed as taxable with a 6% (TAX 1) rate and Clerk #1 is used.

EXAMPLE 35: VOIDING A PLU SALE WITH A COUPON DISCOUNT - (Assume PLU #1 is preset for the price of \$1.00 in Department 1 and deduct a 20¢ coupon. Void this entry):

1. **ENTER (1), PRESS** the [VOID] key, then **PRESS** the [PLU] key.
2. **ENTER (20), PRESS** the [VOID] key, then **PRESS** the [-/CPN] key.
3. **PRESS** the [AMOUNT TEND/TOTAL] key.
- or -
1. **PRESS** the [VOID] key, **ENTER (1)**, then **PRESS** the [PLU] key.
2. **PRESS** the [VOID] key, **ENTER (20)**, then **PRESS** the [-/CPN] key.
3. **PRESS** the [AMOUNT TEND/TOTAL] key.

	-VOID-	
PLU 0001	I	1.00
	-VOID-	
COUPON N	I	0.20
ITEM CT		-1
TAX		-0.04
CASH		-0.84

EXAMPLE 36: VOIDING A PLU SALE WITH A MINUS PERCENTAGE DISCOUNT - (Assume PLU #1 is preset for the price of \$1.00 in Department 1 and the [-%] key is pre-programmed for 10%. Ring up PLU #1, deduct 10%, then void this entry):

1. **ENTER (1)**, then **PRESS** the [PLU] key.
2. **PRESS** the [-%] key.
If the Minus Percentage Discount Rate is NOT pre-programmed, type in the discount rate before pressing the [-%] key.
3. **PRESS** the [AMOUNT TEND/TOTAL] key.
4. **PRESS [VOID], ENTER (1)**, then **PRESS** the [PLU] key.
5. **PRESS** the [-%] key.
6. **PRESS** the [AMOUNT TEND/TOTAL] key.

	-VOID-	
PLU 0001	I	1.00
	10 -%N	-0.10
ITEM CT		-1
TAX		-0.05
CASH		-0.95

EXAMPLE 37: VOIDING A PLU SALE WITH A PLUS PERCENTAGE RATE - (Assume PLU #1 is preset for the price of \$1.00 in Department 1 and the [+%] key is pre-programmed for 10%. Ring up PLU #1, add 10%, then void this entry):

1. **ENTER (1)**, then **PRESS** the [PLU] key.
2. **PRESS** the [+%] key.
If the Plus Percentage Rate is NOT pre-programmed, type in the discount rate before pressing the [+%] key.
3. **PRESS** the [AMOUNT TEND/TOTAL] key.
4. **PRESS [VOID], ENTER (1)**, then **PRESS** the [PLU] key.
5. **PRESS** the [+%] key.
6. **PRESS** the [AMOUNT TEND/TOTAL] key.

	-VOID-	
PLU 0001	I	1.00
	10 +%N	-0.10
ITEM CT		-1
TAX		-0.06
CASH		-1.16

TRANSACTION EXAMPLES FOR OPERATING THE CASH REGISTER

NOTE: Turn the key to the "REG" (REGISTER) position for registering sales transactions.
IMPORTANT: It is not necessary to press the Decimal Point when ringing up a price.
REMINDER: If Clerk Numbers are programmed, be sure to **ENTER** the (CLERK #), then **PRESS** the [CLERK] key before ringing up a sale.

EXAMPLE 38: **ISSUING A DUPLICATE RECEIPT** - (After completion of a sale, a second receipt can be issued).

Note: If desired, a procedure is offered to program the cash register so that the Duplicate Receipt feature will be completely shut off. For details, see Flag 62, on Page 63.

1. **PRESS** the [SUBTOTAL W/TAX] key.

Note: If the Customer Receipt switch is shut off, a duplicate receipt can still be issued by turning the switch on and then pressing the [SUBTOTAL W/TAX] key.

THE MACHINE
WILL DUPLICATE
THE RECEIPT
OF ANY SALE
COMPLETED

The cash register is designed to maintain totals of all transaction data. Transaction data is maintained in the memory of the cash register as long as the system is plugged in and/or the battery back-up system is in effect. This data can be obtained in the "X" or "Z" positions. The read-out for the Management Reports is the same whether it is taken in the "X" or "Z" positions, the only difference is that the totals are reset to zero after a "Z" position reading.

"X" POSITION READING

There are two types of readings that can be taken in the "X" position; an "X1" reading and an "X2" reading. Note: To prevent accidental printing of the "X" reading, a Manager Password can be set. Once the password is set, an "X" report will not print in the "X" position until the password is typed, for details see Page 22.

- **"X1" READING - Commonly known as a "mid-day" reading;** prints an accumulation of transaction data and is not reset to zero unless a "Z1" reading is taken. Use this position to print periodic readings of transaction totals during the course of the day.
- **"X2" READING - Commonly known as a "mid-week" or "mid-month" reading;** prints an accumulation of transaction data and is not reset to zero unless a "Z2" reading is taken. Use this position to print periodic readings of transaction totals during the course of several days. The "X2" report is only available in the "X" position.

"Z" POSITION READING

There are two types of readings that can be taken in the "Z" position; a "Z1" reading and a "Z2" reading. Note: To prevent accidental printing of the "Z" reading, a Manager Password can be set. Once the password is set, a "Z" report will not print until the password is typed, for details see Page 22.

- **"Z1" READING - Commonly known as an "end-of-day/daily-closeout" reading;** prints transaction data and resets all transaction totals to zero except the Running Grand Total. The machine will, however, still accumulate totals in memory until a "Z2" reading is taken. To clear the Running Grand Total, see Page 41.
- **"Z2" READING - Commonly known as a "weekly" or "monthly" reading;** prints transaction totals either on a weekly or monthly basis (not both) and resets all transaction totals to zero except the Running Grand Total.

MANAGEMENT REPORTS AVAILABLE

There are a total of eight different kinds of reports available on the cash register:

- **FULL REPORT** - Includes totals of departments, tax, net sales, voids, returns, coupons, refunds, minus percentage, plus percentage, receipts-on-account, no-sale activity, paid out, cash, check, charge, and the running grand total (only present on "Z" Reports).
- **PLU REPORT** - Lists total quantity and cost of each PLU Number rung up.
- **CLERK REPORT** - Exclusively prints total sales amounts of each Clerk Number operated, tax total or no-sale counter.
- **HOURLY REPORT** - Provides total sales amounts rung up each hour.
- **CASH-IN-DRAWER/CHECK-IN-DRAWER REPORT** - Only available in the "X" position, simply tells you how much cash and the total of all checks is in the drawer at the time of the report.
- **CASH DECLARATION** - Only available in the "Z" position; allows you to declare the actual amount of cash in the drawer and automatically generates the "Z1" (End-of-Day/Daily-Close-out) Report.
- **GROUP REPORT** - Prints sales totals by designated department group.

X/Z MANAGEMENT REPORTS (Continued)

SUMMARY OF MANAGEMENT REPORTS

Report Description	Operation Key	X Report	Weekly/Periodic X Report *	Reset Report	Weekly/Periodic Reset Report *	Training Report
Full Report	AMOUNT TEND/TOTAL	Available	A	A	A	As left
PLU Report	PLU/DEPT ALT + PLU	A	A	A	A	N/A
Hourly Report	PLU/DEPT ALT + QTY/TIME	A	N/A	A	N/A	N/A
Cash & Check In Drawer Report	CHECK/STUBS	A	N/A	N/A	N/A	As left
All Clerk Report	PLU/DEPT ALT + CLERK	A	A	A	A	As left
Individual Clerk Report	PLU/DEPT ALT + CLERK # + CLERK	A	A	A	A	As left
Group Report	DEPT	A	A	N/A	N/A	As left
Department Report	PLU/DEPT ALT + DEPT	A	A	N/A	N/A	As left
Department Range Report	START # + PLU/DEPT ALT + END # + DEPT	A	A	N/A	N/A	As left
Grand Total Report	PLU/DEPT ALT + VOID	N/A	N/A	A	N/A	N/A
PLU Range Report	START # + PLU/DEPT ALT + END # + PLU	A	A	N/A	N/A	N/A
Cash Declaration Report	EC + QTY MONEY + QTY/TIME + AMT MONEY + RA +AMOUNT TEND TOTAL	N/A	N/A	A	N/A	As Left

* To issue Periodic Reports in either "X" or "Z", press [PO] before pressing the appropriate operation key.

The following lists the different Management Reports that are offered in the "X" and "Z" positions:

Key Positions	Report Symbols	Reports Known As	Management Reports Available
X	X1	Mid-Day	Full, PLU, Clerk, Hourly, Cash-In-Drawer, Group, Training, Department
X	X2	Mid-Week or Mid-Month	Full, PLU*, Clerk, Group, Training
Z	Z1	End-Of-Day or Daily-Close-Out	Full, PLU, Clerk, Hourly, Cash Declaration, Training
Z	Z2	Weekly or Monthly	Full, PLU*, Clerk, Training

(Continued) **X/Z MANAGEMENT REPORTS**

In addition to the printed reports, the following totals can be displayed for quick reference at any time but not printed by turning the key to the "X" position and pressing the appropriate keys.

To Display	Press The Following Keys in the "X" Position
Net Total	1 + [QTY/TIME]
Cash Total	2 + [QTY/TIME]
Charge Total	3 + [QTY/TIME]
Check Total	4 + [QTY/TIME]
No Sales Total	5 + [QTY/TIME]
RA Total	6 + [QTY/TIME]
PO Total	7 + [QTY/TIME]
Cash-In-Drawer Total	8 + [QTY/TIME]

X/Z MANAGEMENT REPORTS (Continued)

TO TAKE A CASH-IN-DRAWER/CHECK-IN-DRAWER REPORT

"X" + [CHECK/STUBS]

1. Turn the key to the "X" position.
2. If a Manager Password has been programmed, **ENTER** the (PASSWORD #), then **PRESS** the [CLERK] key now, or if you did NOT program a Manager Password, go to Step 3.
3. **PRESS** the [CHECK/STUBS] key.

	* X 1 *		
	IN DRAWER REPORT		
INDICATES CASH-IN-DRAWER	CAID	58N	
		119.53	SHOWS \$119.53 CASH-IN-DRAW TOTAL
CHECK-IN-DRAWER TOTAL	CKID	1N	
		1.06	SHOWS \$1.06 CASH-IN-DRAW TOTAL
REPORT WAS TAKEN	10-24-2002	PM 04:52	
		0054	TRANSACTION NUMBER
CLERK NUMBER	CLERK01		

TO TAKE AN HOURLY REPORT

"X" or "Z" + [PLU/DEPT ALT] + [QTY/TIME]

1. Turn the key to the "X" or "Z" positions as desired.
2. If a Manager Password has been programmed, **ENTER** the (PASSWORD #), then **PRESS** the [CLERK] key, or if you did NOT program an "X" or a Manager Password, go to Step 3.
3. **PRESS** [PLU/DEPT ALT], then **PRESS** the [QTY/TIME] key.

Important: An hourly reading must be closed out (reset) in the "Z" position.

	* X 1 *		
	HOURLY REPORT		
15:00		14N	
		55.62	SALES TOTAL (including tax) at 15:00 pm
16:00		44N	
		36.93	SALES TOTAL (including tax) at 16:00 pm

TO TAKE A DEPARTMENT RANGE REPORT

"X" + (Department Start #) + [PLU/DEPT ALT] + (End Department #) + [DEPT]
1- 99 1- 99 (2 digits)

* X 1 *	
INDIVIDUAL	DEPT
DEPT01	15.25Q
	38.24
DEPT02	21Q
	45.21
DEPT03	2Q
	4.00
DEPT99	3Q
	3.00
DEPT TTL	41.25Q
	90.45

TO TAKE CLERK REPORT

This report will print totals for all clerks.

"X" or "Z" + [PLU/DEPT ALT] + [CLERK]

1. Turn the key to the "X" or "Z" position as desired.
2. PRESS [PLU/DEPT ALT], then PRESS the [CLERK] key.

* X 1 *	
CLERK REPORT	
CLERK01	
NEL TL	53N
	72.30
VOID	30N
	35.01
TAX	43N
	2.00
NOSALE	2N
	0.00

OF TRANSACTIONS
AMOUNT OF SALES
OF VOID COUNTER
AMOUNT OF VOIDS
OF TAX COUNTER
TOTAL TAX CHARGES

X/Z MANAGEMENT REPORTS (Continued)

TO TAKE AN INDIVIDUAL CLERK REPORT

"X or Z" + [PLU/DEPT ALT] + (Security #) + [CLERK]
4 digits (maximum)

1. Turn the key to the "X" or "Z" position as desired.
2. PRESS the [PLU/DEPT ALT] key.
3. ENTER (the Clerk Security Number), then PRESS the [CLERK] key.

* X 1 *			
INDIVIDUAL CLERK			
CLERK02			
NET TL	2N	8.10	— AMOUNT OF SALES
TAX	2N	0.12	— TOTAL TAX CHARGES

TO TAKE A PLU REPORT

"X" or "Z" + [PLU/DEPT ALT] + [PLU]

1. Turn the key to the "X" or "Z" position as desired.
2. If a Manager Password has been programmed, ENTER the (PASSWORD #), then PRESS the [CLERK] key,
or if you did NOT program a Manager Password, go to Step 3.
3. PRESS [PLU/DEPT ALT] , then PRESS the [PLU] key.

Important: A PLU Reading must be closed out in the "Z" position.

* X 1 *			
PLU REPORT			
1			
PLU NUMBER OR DESCRIPTION — PLU 0001	2Q	2.50	— QUANTITY OF PLU's RUNG UP
			— TOTAL AMOUNT OF PLU's RUNG UP
2			
PLU 0002	1Q	2.00	
3			
PLU 0003	3Q	9.00	
4			
PLU 0004	1Q	4.00	

TO TAKE A CASH DECLARATION REPORT

"Z" + [EC] + (Quantity of Money) + [QTY/TIME] + (Amount of Money) + [RA] + [AMOUNT TEND/TOTAL]

CAUTION: The Cash Declaration feature will not allow any corrections of miscalculated or incorrect entries of the cash declared. Therefore, please double check and verify all money before getting started.

Example: Declare the following money in the drawer: 3 five dollar bills, 7 one dollar bills and 4 quarters:

- 1. Turn the key to the "Z" position.
2. If a Manager Password has been programmed, ENTER the (PASSWORD #), then PRESS the [CLERK] key, or if you did NOT program a Manager Password go to Step 3.
3. PRESS the [EC] key.
4. ENTER (3), PRESS the [QTY/TIME] key, ENTER (500), then PRESS the [RA] key.
5. ENTER (7), PRESS the [QTY/TIME] key, ENTER (100), then PRESS the [RA] key.
6. ENTER (4), PRESS the [QTY/TIME] key, ENTER (25), then PRESS the [RA] key.
7. PRESS the [AMOUNT TEND/TOTAL] key to finalize.

NOTE: The cash register will automatically produce a "Z1" (End-of Day or Daily-Close-Out) Reading when the Cash Declaration feature is used.

Table showing cash declaration details: * Z 1 * CASH DECLARATION, R/A 3Q @5.00, R/A 7Q @1.00, R/A 4Q @0.25, TOTAL 23.00, CAID 23.00, DIFFERENCE 0.00, FULL REPORT, DEPT02 1Q 23.00, DEPT TTL 1Q 23.00, NET TL 23.00, CASH 1N 23.00, CAID 1N 23.00, RPRT CNT 0002, NRGT 137.03. Includes annotations like 'Z1' READING TAKEN and 'REGULAR Z1 TAPE FOLLOWS'.

(Continued)

X/Z MANAGEMENT REPORTS (Continued)

TO TAKE A DEPARTMENT GROUP REPORT

Departments can be linked together to form up to nine groups for the purpose of keeping a summary total. This is done when programming the Department Status, see Pages 28-32.

For example, if Department 1, 2 and 3 represent beverage sales, i.e., DEPT 1; tea, DEPT 2; coffee, DEPT 3; soda, these three departments can be linked as Group 1 in order to provide a total representing total beverage sales. This eliminates manually adding these department totals at the end of the day.

TO TAKE A GROUP REPORT

"X" + [DEPT]

1. Turn the key to the "X" position as desired.
2. If a Manager Password has been programmed, **ENTER** the (PASSWORD #), then **PRESS** the [CLERK] key, or if you did NOT program a Manager Password, go to Step 3.
3. **PRESS** [DEPT] key.

* X 1 *	
GROUP REPORT	
DEPT GRP	0
DEPT01	22.25Q
	46.24
DEPT02	24Q
	54.21
DEPT03	3Q
	8.00
DEPT99	3Q
	3.00
GROUP TTL	52.25Q
	111.45

TOTAL COUNT
AMOUNT

TO TAKE A FULL REPORT

"X" or "Z" + [AMOUNT TEND/TOTAL]

1. Turn the key to the "X" or "Z" position as desired.
2. If a Manager Password has been programmed, ENTER the (PASSWORD #), then PRESS the [CLERK] key, or if you did NOT program a Manager Password, go to Step 3.
3. PRESS the [AMOUNT TEND/TOTAL] key.

Important: A Full Reading must be closed out in the "Z" position.

SEE ILLUSTRATION OF A FULL REPORT ON THE NEXT PAGE.

TO TAKE A (WEEKLY or MONTHLY) FULL REPORT

"X" or "Z" + [PO] + [AMOUNT TEND/TOTAL]

1. Turn the key to the "X" or "Z" position as desired.
2. If a Manager Password has been programmed, ENTER the (PASSWORD #), then PRESS the [CLERK] key, or if you did NOT program a Manager Password, go to Step 3.
3. PRESS [PO], then PRESS the [AMOUNT TEND/TOTAL] key.

X/Z MANAGEMENT REPORTS (Continued)

"Z1" READING - FULL REPORT ILLUSTRATION

* Z 1 *		FULL REPORT	
DEPARTMENT	DEPT01	22.25Q	ACTIVITY COUNTER
		46.24	DEPARTMENT TOTAL
	DEPT02	24Q	
		54.21	
	DEPT03	3Q	
		8.00	
	DEPT99	3Q	
		3.00	
	DEPT TTL	52.25Q	DEPARTMENT TOTAL COUNTER
		111.45	ALL DEPARTMENT TOTALS
	NOTXBL	22N	NON-TAXABLE COUNTER
		65.01	NON-TAXABLE AMOUNT
	TXBL-1	49N	TAXABLE COUNTER
		46.24	TAXABLE AMOUNT
	TAX-1	2.78	TAX 1 AMOUNT
	+%G	1N	+%G COUNTER
		0.10	+%G AMOUNT
	VOID-R	25N	VOID COUNTER
		29.21	VOID AMOUNT
	RETURN	2N	RETURN COUNTER
		5.50	RETURN AMOUNT
	COUPON G	1N	COUPON GROSS COUNTER
		0.20	COUPON GROSS AMOUNT
	-%G	1N	-%G COUNTER
		0.10	-%G AMOUNT
	NET TL	114.03	NET SALES TOTAL
	CASH	57N	CASH SALES COUNTER
		101.01	CASH SALES AMOUNT
	CHECK	1N	CHECK SALES COUNTER
		1.06	CHECK SALES AMOUNT
	CHARGE	2N	CHARGE SALES COUNTER
		11.96	CHARGE SALES AMOUNT
	+%N	7N	+%N COUNTER
		0.20	+%N AMOUNT
	-%N	9N	-% NET COUNTER
		0.40	-% NET AMOUNT
	MSC-V	7N	# OF VOIDS
		1.10	TOTAL AMOUNT OF VOIDS
	R/A CA	1N	RECEIVED ON ACCOUNT COUNTER
		50.00	RECEIVED ON ACCOUNT AMOUNT
	P/O CA	1N	PAID OUT COUNTER
		10.00	PAID OUT AMOUNT
	TAXTOTAL	2.78	TAX TOTAL
	NET-TAX	111.25	NET-TAX
	CAID	59N	CASH-IN-DRAWER COUNTER
		141.01	CASH-IN-DRAWER AMOUNT
	CKID	1N	CHECK-IN-DRAWER COUNTER
		1.06	CHECK-IN-DRAWER AMOUNT
	NOSALE	2N	NO SALE COUNTER
		0.00	NO SALES AMOUNT
	RPRT CNT	0001	REPORT COUNTER
	NRGT	114.03	GRAND TOTAL
	CLERK01		
	NET TL	54N	
		93.78	
	VOID	30N	
		35.01	
	TAX	44N	
		2.48	
	NOSALE	2N	
		0.00	
	CLERK02		
	NET TL	2N	
		8.10	
	TAX	2N	
		0.12	

(Continued) X/Z MANAGEMENT REPORTS

The following illustrates how totals are calculated for the Management Reports.

NET SALES TOTAL - Represents the true sales for the day. The net sales total includes department total (TL) and tax total (TX).

NOTE: Minus percentage discount (-%), voids (VD) and returns/refunds (RT) are all deducted from the department totals and the plus percentage (+%) is added to the department totals.

GROSS SALES - Represents the total of all sales registered. The Gross Sales includes net sales total (NS), coupon discount (-), minus percentage discount (-%), return/refund (RT), and void (VD).

SYSTEM BALANCE:

DEPARTMENT 1	(+)	49.29
DEPARTMENT 2	(+)	118.17
DEPARTMENT 3	(+)	57.46
DEPARTMENT 4	(+)	15.77
<hr/>		
DEPARTMENT TOTAL	(=)	240.69
DEPARTMENT TOTAL	(+)	240.69
TAX TOTAL	(+)	9.55
<hr/>		
NET SALES TOTAL	(=)	250.24
NET SALES TOTAL	(+)	250.24
COUPON DISCOUNT	(-)	5.00
MINUS PERCENTAGE	(-)	.14
RETURN/REFUND	(+)	10.00
VOID	(+)	12.00
<hr/>		
GROSS SALES	(=)	267.10

MEDIA BALANCE:

NET SALES TOTAL	(+)	250.24
CHECK TOTAL	(-)	44.01
CHARGE TOTAL	(-)	74.19
RECEIVED-ON-ACCOUNT (Cash)	(+)	100.00
PAID OUT (Cash)	(-)	5.00
<hr/>		
CASH-IN-DRAWER	(=)	227.04

PC INTERFACE AND SOFTWARE

INTERFACE AND SOFTWARE

The machine can communicate with your PC via the modular jack RJ45 serial port and the enclosed custom serial cable.

The COM ports are on the lower right side of the cash register. Please refer to the Flag # 73, on Page 64.

Also enclosed is a CD containing RegisterLink[®] PC-based software that allows the register to communicate with your PC. It also contains software filter to download your end-of-day totals into QuickBook[®] and Peachtree[®] accounting software packages.

If you have any questions regarding the software, please call our Software Technical Support at 971-249-0300.

Note: All trademarks and service marks referenced above and elsewhere in this manual are for identification purposes only and are the property of their respective holders.

Please select and follow the procedure which best describes the cash register condition:

1. IN CASE OF AN ERROR TONE OR IF "E" DISPLAYS:

- a. **PRESS** the [CLEAR] key.
- b. **Turn the key to the last position (PRG, REG, X or Z)** you were in prior to receiving the error. If the last position you were in was "REG", **turn the key to the "REG" position** and **PRESS** the [CLEAR] key, then **PRESS** the [AMOUNT TEND/TOTAL], [CHECK/STUBS], or [CHARGE] key to complete a pending sale. If your last position was "PRG", **turn the key to the "PRG" position**, **PRESS** the [CLEAR] key, and then **PRESS** the [#/ST/NS] key.
- c. Double check and repeat the procedure you are trying to perform.
- d. If error still persists, perform a HALF SYSTEM CLEAR procedure (see below).
- e. As a last resort, perform a FULL SYSTEM CLEAR procedure (see below).

2. IF PRINTING PROBLEMS OCCUR:

- a. Check if you are out of paper.
- b. Check for a paper jam. If so, **carefully** remove any paper obstructing the printer. CAUTION: **DO NOT** manually pull the paper, always use the paper feed key to remove or advance the paper.
- c. Once the paper jam has been successfully removed, reinstall a new paper roll if necessary, see Pages 10-12.

Important: Avoid using any type of sharp or pointed objects in or around the printer area when attempting to clear a paper jam.

3. IF THE CASH REGISTER IS MALFUNCTIONING:

- a. Be sure the cash register is plugged into a working electrical outlet and no other electrical device is using the same power source. Another electrical motor on the same circuit could cause interference with register operations.
- b. Perform a HALF SYSTEM CLEAR procedure (see below).
- c. As a last resort, follow the directions for a FULL SYSTEM CLEAR procedure (see below).

4. OPENING THE DRAWER IN AN EMERGENCY:

Push the drawer opening lever to the left (located at the rear of the bottom of the cash register) to open the drawer in an emergency in case of a power failure or a cash register malfunction.

HALF SYSTEM CLEAR PROCEDURE:

- a. Turn the key to the "PRG" position.
- b. Unplug the cash register from the power source (pause for 10 seconds) and replug the cash register.
- c. Continue with normal operations.

FULL SYSTEM CLEAR PROCEDURE:

Note: This procedure will erase all transaction totals and programming.

- a. Turn the key to the "PRG" Position.
- b. Unplug the cash register from the power source and wait at least 15 seconds.
- c. While holding down the [CLEAR] key, replug the cash register.
- d. Re-program the cash register.
- e. Continue with normal operations.

If a problem still persists, contact a Royal Authorized Service Center. For the location of the one nearest you, call (888) 261-3888 during East Coast business hours.

SPECIFICATIONS AND SAFETY

MODEL:	Royal Alpha 9155sc
TYPE:	Electronic cash register with printer and 99 departments.
DISPLAY:	Front: 10 digit Union Jack/Numeric, 11.5mm x 2 lines Rear: As above.
CAPACITY:	7 digit input and 10 digit readout.
PRINTER:	ECR exclusive 1-Station thermal printer 2.
PAPER SUPPLY:	58mm thermal paper.
MEMORY BATTERY PROTECTION:	Approximately 6 months after installation of battery.
TECHNOLOGY:	CMOS RAM
POWER CONSUMPTION:	Standby - 18W, Operating - 35W max.
OPERATING TEMPERATURE:	32-104 Degrees Fahrenheit (0-40 Degrees Centigrade).
DIMENSIONS:	16.1 (W) x 17.3 (D) x 12.0 (H)
WEIGHT:	22.0 lbs.

SAFETY NOTICE

The main outlet for this cash register must be located near the unit and easily accessible.
Do not use this cash register outdoors in the rain or near any source of liquid.

WARNING

"This equipment generates, uses and can radiate radio frequency energy and if not installed and used in accordance with the instruction manual, may cause interference to radio communications. It has been tested and found to comply with the limits for a Class A computing device pursuant to Subpart J of Part 15 of FCC Rules, which are designed to provide reasonable protection against such interference when operated in a commercial environment. Operation of this equipment in a residential area is likely to cause interference in which case the user at his own expense will be required to correct the interference."

CAUTION

RISK OF EXPLOSION IF BATTERY IS REPLACED WITH AN INCORRECT TYPE.
DISPOSE OF USED BATTERIES ACCORDING TO THE INSTRUCTIONS.

ATTENTION

Il y a danger d'explosion s'il y a remplacement incorrect de la batterie.

Remplacer uniquement avec une batterie du même type ou d'un type équivalent recommandé par le constructeur.

Mettre au rebut les batteries usagées conformément aux instructions du fabricant.

YOUR BACK-UP POWER SYSTEM: When you are not using your cash register, you should keep it plugged in with the control lock in the "OFF" position. Back-up power is provided via battery, but this should not be used for sustained periods of time.

LIMITED WARRANTY

ROYAL ELECTRONIC CASH REGISTER LIMITED WARRANTY

Royal Consumer Information Products, Inc., 379 Campus Drive, PO Box 6786, Somerset, New Jersey 08875 warrants that your NEW Royal Cash Management System is free of defects of workmanship and materials. If there is a defect or malfunction of this cash register, Royal will repair the cash register free of charge as follows:

PARTS: New or comparable rebuilt parts in exchange for defective parts for ONE YEAR from the date of purchase.

LABOR: All labor charges incurred for 90 DAYS are covered from the date of purchase. Royal will pay return postage during labor warranty period only.

This warranty does not apply to persons who purchase this product second hand or used.

This warranty does not include adjustments, parts, or repairs required by circumstances beyond the control of Royal, including but not limited to fire or other casualty, accident, neglect, abuse, abnormal use, or battery leakage damages. THERE ARE NO OTHER EXPRESSED WARRANTIES EXCEPT AS STATED HEREIN. AFTER THE PERIOD OF EXPRESSED WARRANTY SET FORTH HEREIN, THERE ARE NO EXPRESSED OR IMPLIED WARRANTIES AND THOSE EXCLUDED INCLUDE THOSE OF MERCHANTABILITY AND FITNESS FOR A PARTICULAR PURPOSE. Royal shall NOT be liable for CONSEQUENTIAL DAMAGES resulting from any failure, defect, or malfunction of this cash register. Some states do not allow limitations on how long an implied warranty lasts and some states do not allow the exclusion or limitation of incidental or consequential damages, so the above limitations or exclusions may not apply to you.

TO OBTAIN SERVICE UNDER THE TERMS OF THIS WARRANTY:

- Pack your cash register in the original carton or equivalent.
- Enclose a copy of the bill of sale or other documentation showing original purchase date.
- Enclose a card or note describing the difficulty you have had with the cash register.
Be sure to include your complete name and address.
- Mail the above prepaid and insured to the nearest authorized service location. The Service Center cannot be held responsible for any loss or damage in transit.
- For Authorized Service Centers within your local area, please call 888-261-3888.

Please retain proof of purchase to establish date of original purchase.

Your warranty starts with the date of original purchase. This warranty gives you specific legal rights, and you may also have other rights which vary from State to State.

- This warranty is valid only on cash registers purchased, delivered and used in the United States and Canada.

ROYAL Alpha 9155sc Electronic Cash Register ACCESSORIES ORDER FORM

ITEM DESCRIPTION	PART NUMBER
1. Protective Keytop Cover	013220
2. Replacement 5 Slot Bill Tray & Drawer (Coin Tray included)	Z1N26X-0016GI
3. Replacement Coin Tray (5-Slot)	Z1N260-0316
4. Duplicate Cash Drawer (#515 - set of 2 keys)	Z1THL-C515K
5. Duplicate Control Lock Key (Manager Key #33I and Operator Key #33A - 2 each)	Z0S0811K
6. Replacement Journal Paper Roll Spindle	Z9SP-285E
7. Thermal Paper (38mm)	013127
8. Owner's Manual	ALPHA9155SCIM303A
9. Bar Scanner (replacement only – same model/style as the scanner originally packed with the cash register)	Z0BP01-CT003A

For Prices and Availability

CALL 1-888-261-4555 Monday - Friday 8:30 - 5:00 p.m. (E.S.T.)

or visit our web site at

www.royalsupplies.com

Prices and Availability Subject to Change Without Notice

CALCULATING BREAKPOINTS

IMPORTANT: This is a one time only procedure. Once the code for the tax table has been established and entered into the register, it never has to be repeated. Please take the time to follow the example given and familiarize yourself with the method of determining the code. Then using the **Worksheet** that follows, fill in the appropriate amounts from your approved tax table and derive the corresponding code by simply following the steps given.

Every tax table consists of tax brackets. Each consecutive tax bracket is assigned a tax which is exactly one cent higher than that assigned to the previous tax bracket. In the **Program Example** that follows a sale from 0¢ to 14¢ is not taxed. However, in the next tax bracket a sale from 15¢ to 37¢ is taxed 1¢. Likewise, in the next tax bracket a sale from 38¢ to 62¢ is taxed 2¢. The tax table progresses in a similar form.

The difference between the starting amounts of each consecutive tax bracket is call a "breakpoint". Every tax table consists of a particular sequence of breakpoints. In the **Program Example** that follows, the difference between 0¢ and 15¢ is 15¢. Therefore 15 is the first breakpoint. Likewise, the difference between 15¢ and 38¢ is 23¢. Therefore 23 is the second breakpoint. The breakpoints progress in a particular sequence throughout the entire tax table. This particular sequence of breakpoints is used to determine the programming code.

The sequence of breakpoints is divided into "Regular" and "Irregular" patterns. All tax tables repeat a pattern of regular breakpoints after a lower irregular breakpoint pattern. To determine the breakpoint patterns, it is first necessary to calculate the breakpoints. This is easily done by using the **Worksheet** that follows. Simply fill in Chart A with the amounts from your approved tax table. Then calculate the breakpoints as was previously explained and fill them in on Chart B. Continue to calculate the breakpoints until you have found the "Regular" repeat breakpoint pattern.

Please refer to the **Program Example**. Note the following:

Breakpoints - 15, 23, 25, 25, 25, 30, 36, 34, 30 - Represents the "Irregular" pattern.
 Breakpoints - 29, 28, 29, 29, 28, 29, 28 - Represents the "Regular" repeat pattern.

As a check to ensure that the "Regular" repeat pattern has correctly been located, add up all the breakpoints of the pattern. In most cases the resulting number will be a multiple of a dollar (i.e. \$1.00 or \$2.00) or must be a number that will divide evenly into a dollar (i.e. 10¢, 25¢, 50¢). In the **Program Example**, the breakpoints -29, 28, 29, 29, 28, 29, 28 add up to 200.

Entering the Program Code:

Once you have filled in both Chart A and Chart B and have determined the "Irregular" and "Regular" breakpoint patterns, you are ready to derive the necessary program code from this information.

There are seven (7) steps necessary. Please refer to the **Program Example** for additional illustrations of the steps.

STEP A: Type the Tax Number (**1, 2 or 3**) you want the tax code assigned to, then press the **(PO)** key.

NOTE: Tax Tables cannot be assigned to Tax 4.

PROGRAM EXAMPLE: (Tax 1)

TYPE
(12)

PRESS
(Tax 1)

STEP B: Enter the first amount (lower amount) of the last tax bracket of the "Irregular" breakpoint sequence. Then press the **(TAX2)**.

NOTE: Do not enter this amount by using the (.) Decimal Point key.

PROGRAM EXAMPLE:

TYPE	PRESS
(243)	(Tax 2)

STEP C: Enter the total of all the breakpoints of the "Regular" breakpoint sequence, then press the **(TAX 2)** key.

PROGRAM EXAMPLE: Regular breakpoint sequence 29+28+29+29+28+29+28=200

TYPE	PRESS
(200)	(Tax 2)

STEP D: Enter the difference between the last tax amount applicable to the "Regular" breakpoint sequence and the last tax amount applicable to the "Irregular" breakpoint sequence. Then press the **(TAX2)** key.

PROGRAM EXAMPLE: $0.16 - 0.09 = 0.07$

TYPE	PRESS
(7)	(Tax 2)

STEP E: Enter the individual breakpoints of the "Irregular" breakpoint sequence, then press the **(SUBTOTAL W/TAX)** key. **The (TAX2) key must be pressed after each breakpoint entry.**

PROGRAM EXAMPLE: Irregular breakpoint sequence: 15,23,25,25,25,30,36,34,30

TYPE	PRESS
(15)	(Tax 2)
(23)	(Tax 2)
(25)	(Tax 2)
(25)	(Tax 2)
(25)	(Tax 2)
(30)	(Tax 2)
(36)	(Tax 2)
(34)	(Tax 2)
(30)	(Tax 2)

STEP F: Enter the individual breakpoints of the "Regular" breakpoint sequence, then press the **(SUBTOTAL W/TAX)** key. **The (TAX2) key must be pressed after each breakpoint entry.**

PROGRAM EXAMPLE: Regular breakpoint sequence: 29,28,29,29,28,29,28

TYPE	PRESS
(29)	(Tax 2)
(28)	(Tax 2)
(29)	(Tax 2)
(29)	(Tax 2)
(28)	(Tax 2)
(29)	(Tax 2)
(28)	(Tax 2)

STEP G: Press the **(#/ST/NS)** key to end and store the program.

NOTE: Print a Verification List of the tax table program and keep it in a safe place:

"PRG" + (999999) + [AMOUNT TEND/TOTAL]

In the event you need to perform a Total System Clear, all programs are cleared from memory. You will have a reference copy to quickly re-enter the program.

CALCULATING STATE TAX TABLE CODES

Program Example

		CHART A TAX BRACKET			
		CHART B Breakpoints	From	To	Tax
			\$0.00	\$0.14	\$0.00
		15	0.15	0.37	0.01
		23	0.38	0.62	0.02
		25	0.63	0.87	0.03
STEP E Enter the individual Breakpoints of the "Irregular" Breakpoint sequence. (15,23,25,25,25,30,36,34,30)		25	0.88	1.12	0.04
		25	1.13	1.42	0.05
		30	1.43	1.78	0.06
		36	1.79	2.12	0.07
		34	2.13	2.42	0.08
		30	2.43	2.71	0.09
		29	2.72	2.99	0.10
		28	3.00	3.28	0.11
		29	3.29	3.57	0.12
		29	3.58	3.85	0.13
STEP C Enter the summation of the Breakpoints for the "Regular" Breakpoint sequence. (200)		28	3.86	4.14	0.14
		29	4.15	4.42	0.15
		28	4.43	4.71	0.16
		29	4.72	4.99	0.17
		28	5.00	5.28	0.18
STEP F Enter the individual Breakpoints of the "Regular" Breakpoint sequence. (29,28,29,29,28,29,28)		29	5.29	5.57	0.19
		29	5.58	5.85	0.20
			"	"	"

STEP B

Enter first amount of the last tax bracket in the "Irregular" breakpoint sequence. (243)

STEP D

Enter the difference between the last tax amount applicable to the "Regular" Breakpoint sequence and the last tax amount applicable to the "Irregular" Breakpoint sequence. (7)

The tax table will progress in a similar manner.

Note: If necessary, a total of 65 Breakpoints can be programmed.

This cash register includes the following functions for taxation in Canada.

METHOD 1: GST Tax: 7%
 PST Tax: 8%
 GST/PST Tax: Both 7% and 8% calculated on net amount

1. Program Tax 1 as 7%:
 "PRG" + (10) + [TAX1] + (70000) + [TAX2] + (0) + [NON TAX]
2. Program Tax 2 as 8%:
 "PRG" + (20) + [TAX1] + (80000) + [TAX2] + (400) + [NON TAX]
3. a. Link Tax 1 (7% GST) to the desired Department key:
 "PRG" + (1) + [SUBTOTAL W/TAX] + (Preset price) + [DEPT1] + [CHECK/STUBS]
 b. Link Tax 2 (8% PST) to desired Department key:
 "PRG" + (2) + [SUBTOTAL W/TAX] + (Preset price) + [DEPT2] + [CHECK/STUBS]
 c. Link both Tax 1 (GST) and Tax 2 (PST) to desired Department key:
 "PRG" + (3) + [SUBTOTAL W/TAX] + (Preset price) + [DEPT3] + [CHECK/STUBS]
4. When more than one tax rate is used, to print the individual tax amounts on the receipt and journal:
 "PRG" + (34) + (1) + [VOID]
 Note: For other options of Flag 31 to 36, see Page 61 for details.
5. a. **PST Exempt Amount:** In certain areas, there is a value below which PST tax is exempted; for example, any amount below \$4.00* is exempted from PST. To set this base amount:
 "PRG" + (20) + [TAX1] + (80000) + [TAX2] + (400) + [NON TAX]
 * Example only, the base of the maximum PST exempt amount may differ from province to province.
 b. To set the net value as the base for the maximum tax exempt amount (i.e., if an item of \$4.00 is entered, no PST shall be added):
 "PRG" + (82) + (1) + [VOID] : Canadian Tax System.
 "PRG" + (83) + (0) + [VOID] : Net Value.
 c. To set the gross value (net amount + GST) as the base for the maximum tax exempt amount (i.e., if an item of \$4.00 is entered, PST will be added because \$4.00 + GST tax exceeds the maximum tax exempt amount of \$4.00):
 "PRG" + (82) + (1) + [VOID] : Canadian Tax System.
 "PRG" + (83) + (1) + [VOID] : Gross Value.

METHOD 2: GST Tax: 7%
 PST Tax: 8%
 GST/PST Tax: Both 7% and 8% as tax on tax - piggyback calculation

1. Program Tax 1 as 7%:
 "PRG" + (10) + [TAX1] + (70000) + [TAX2] + (0) + [NON TAX]
2. Program Tax 2 as 8%:
 "PRG" + (20) + [TAX1] + (80000) + [TAX2] + (0) + [NON TAX]
3. Program Tax 3 as 8%:
 "PRG" + (30) + [TAX1] + (80000) + [TAX2] + (0) + [NON TAX]

4. a. Link Tax 1 (7% GST) to the desired Department key:
"PRG" + (1) + [SUBTOTAL W/TAX] + (Preset price) + [DEPT1] + [CHECK/STUBS]
- b. Link Tax 3 (8% PST) to the desired Department key:
"PRG" + (4) + [SUBTOTAL W/TAX] + (Preset price) + [DEPT3] + [CHECK/STUBS]
- c. Link both Tax 1 (7% GST) and Tax 2 (8% PST) to the desired Department key:
"PRG" + (3) + [SUBTOTAL W/TAX] + (Preset price) + [DEPT4] + [CHECK/STUBS]
- d. Program for piggyback (tax on tax) calculation and Canadian tax system:
"PRG" + (82) + (1) + [VOID] : Canadian Tax System.
"PRG" + (85) + (1) + [VOID] : Not add TAX3 to TAX1.

* For other options of Flag 82 to 86, see Page 65.

If the PST Exempt Amount must be programmed, see Number 5 under Method 1.

If you require additional assistance, please call Royal Customer Support at 1-908-429-4357 during East Coast business hours.

**Z1AE - 0936
0303**

**Royal Consumer Information Products, Inc.
379 Campus Drive
Somerset, NJ 08875**

ALPHA9155SCIM303A
Printed in China